

# PROJECT SAMPLES

# STRUCTURE BIM SAMPLES

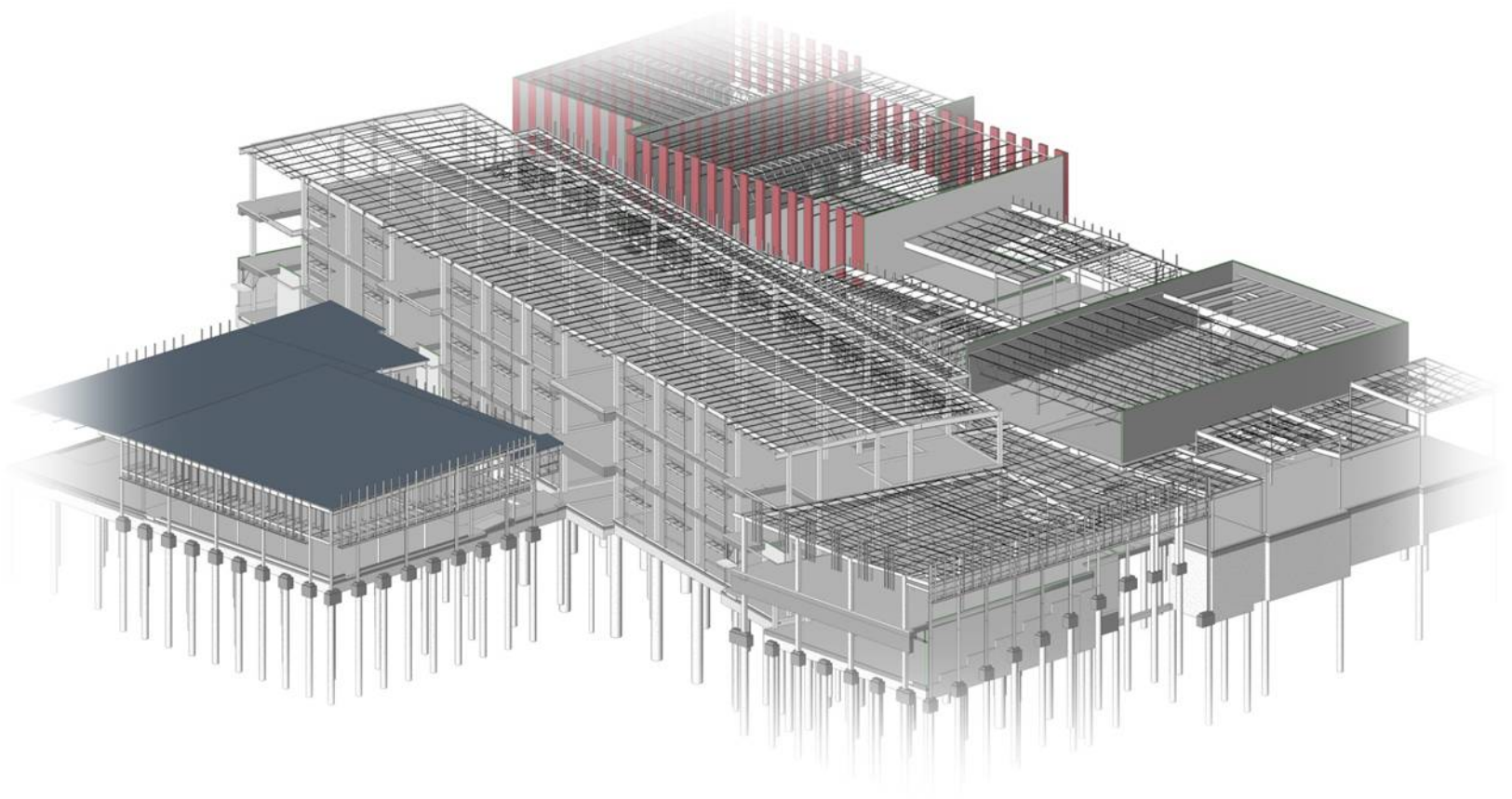

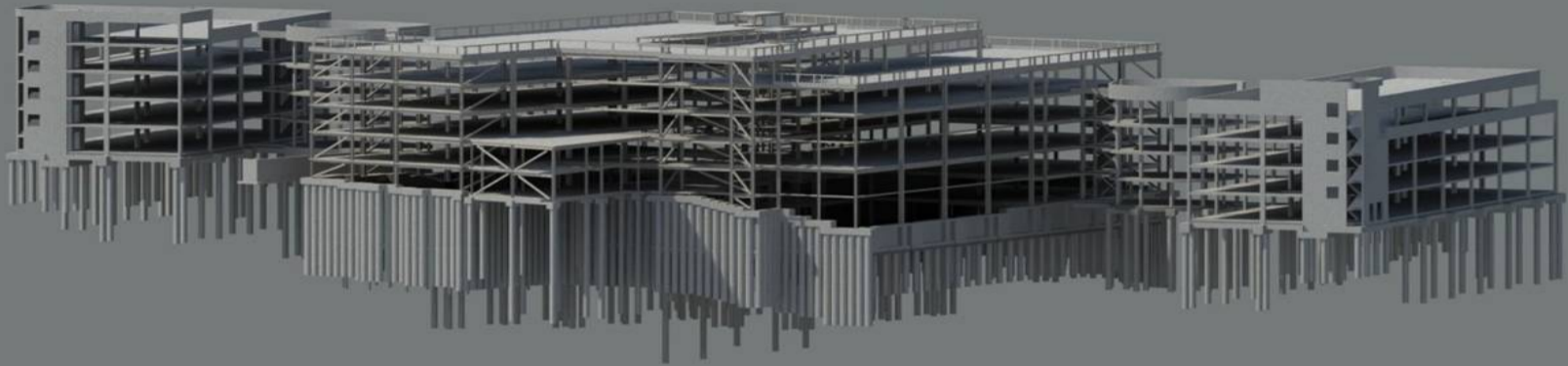

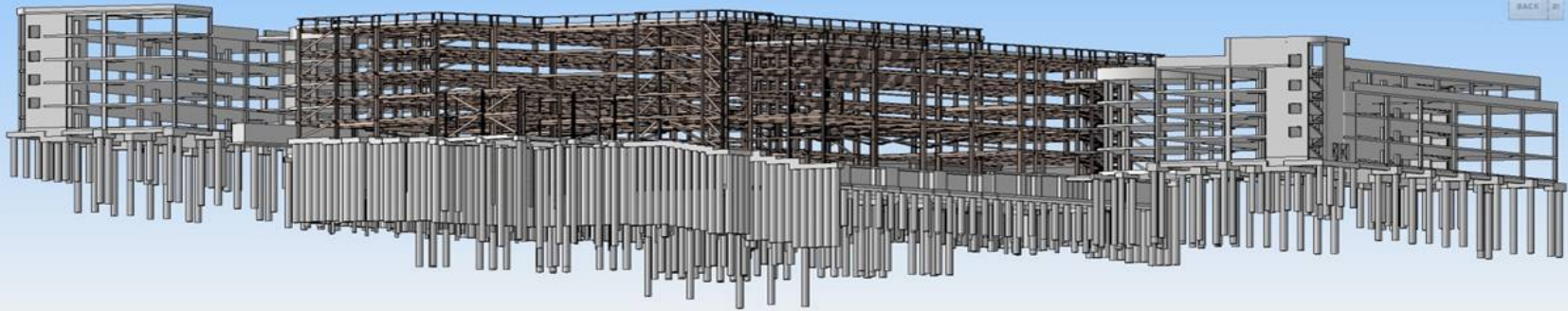

BACK



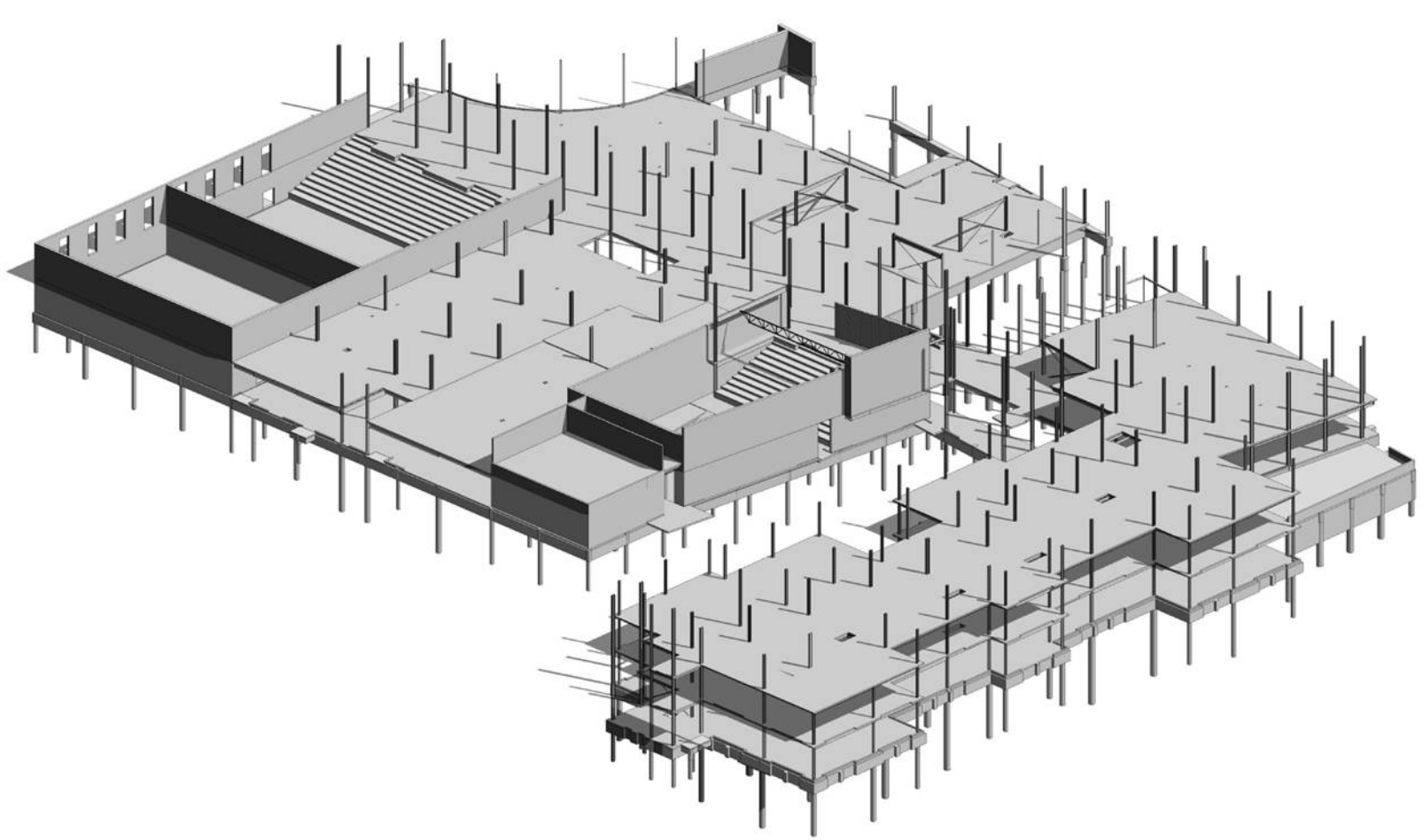

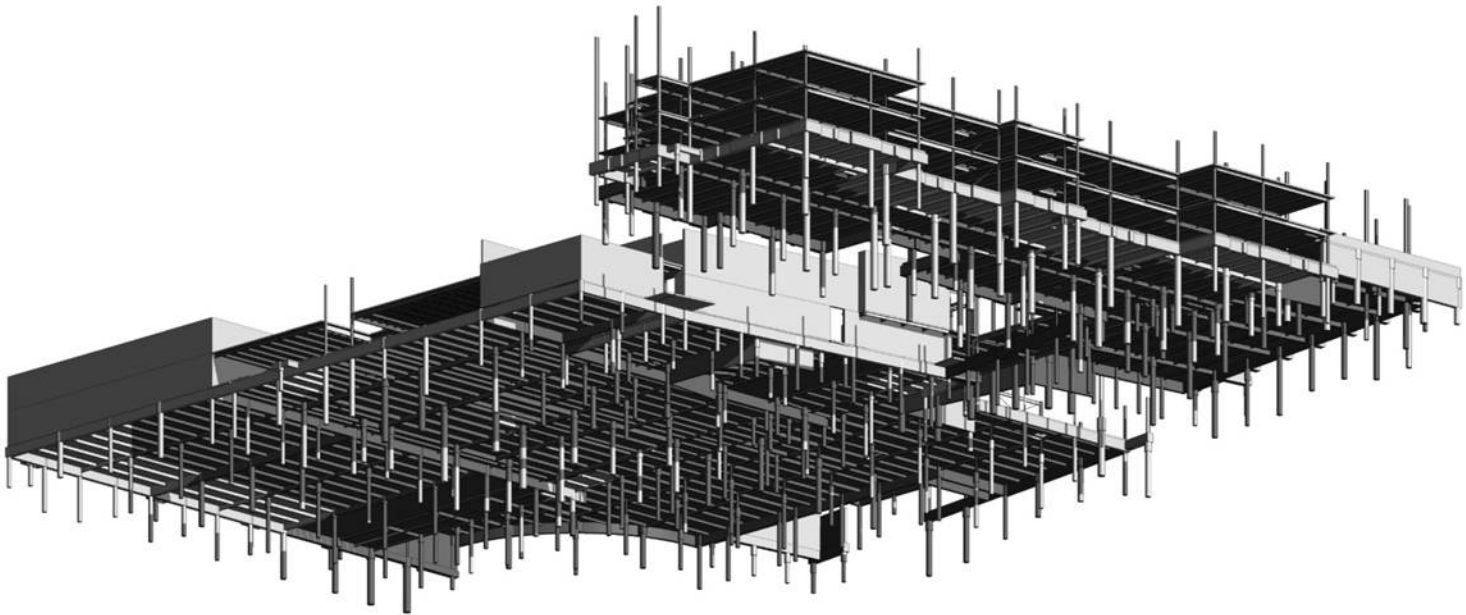

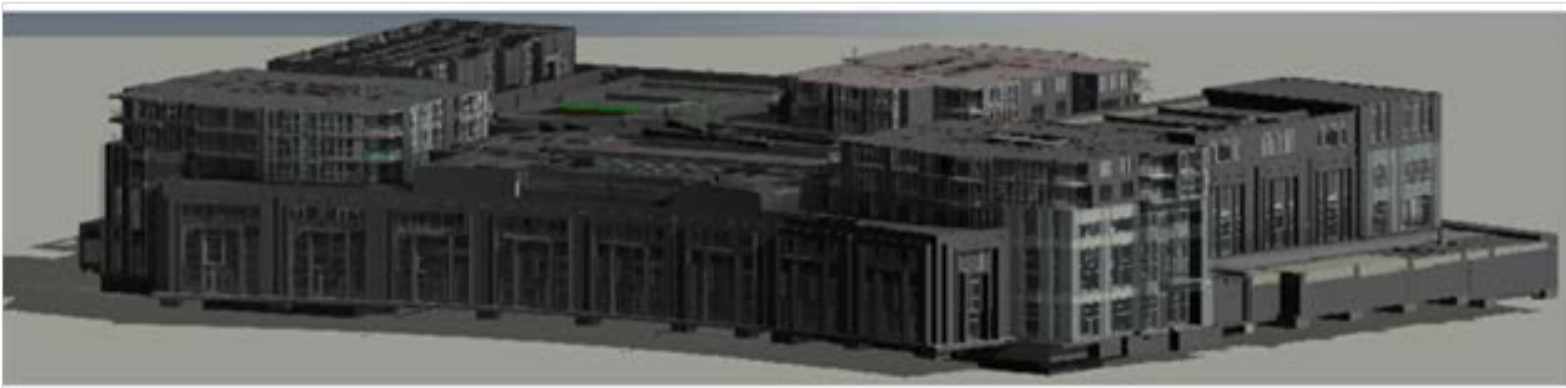



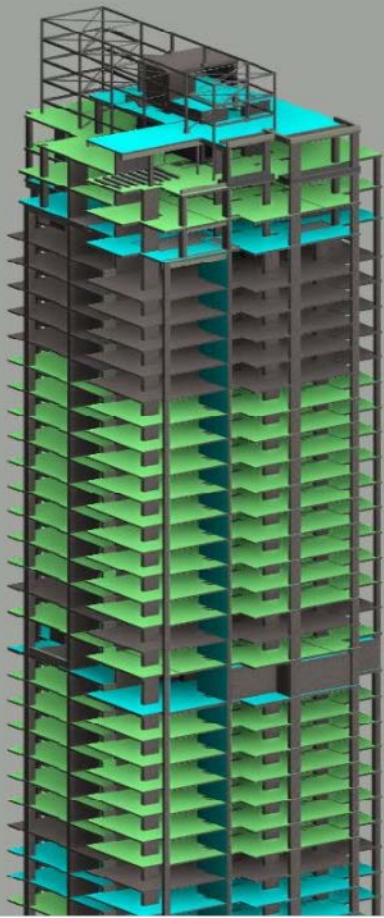

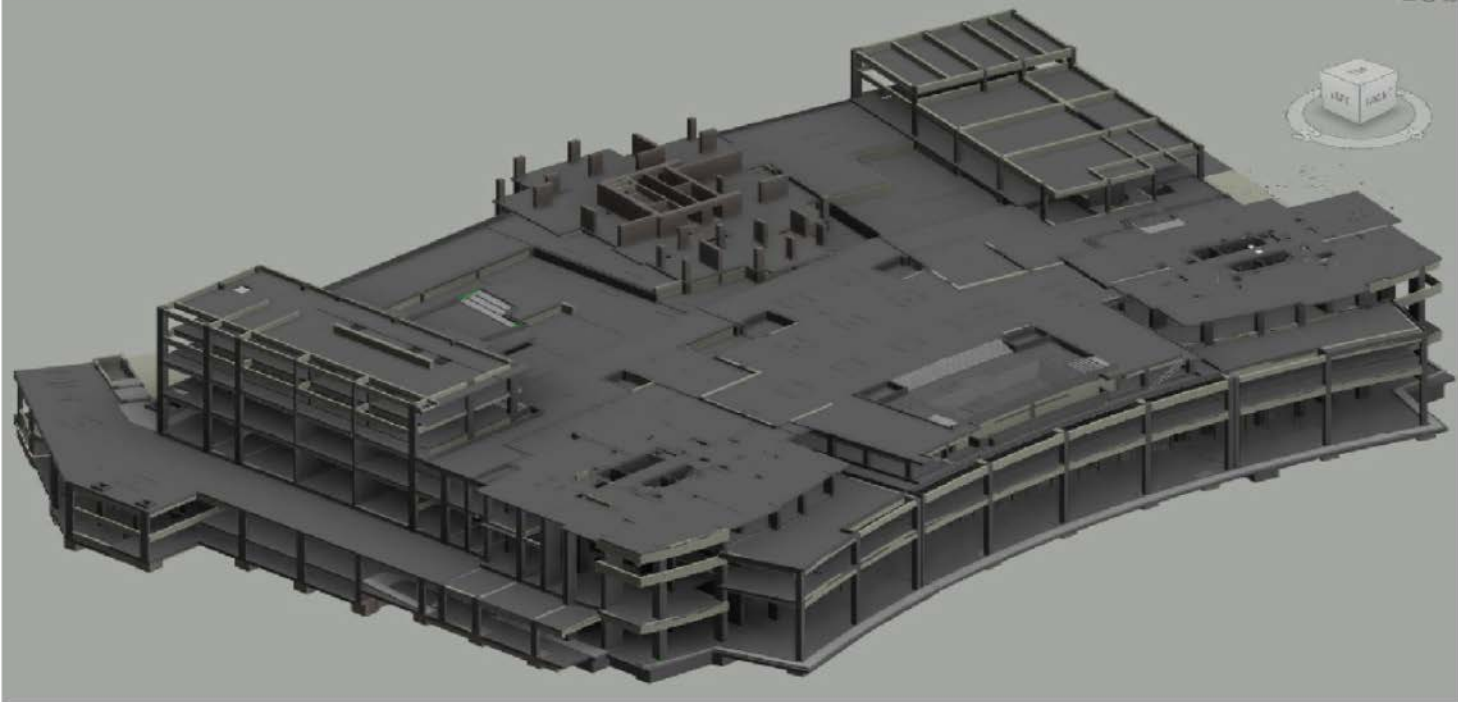

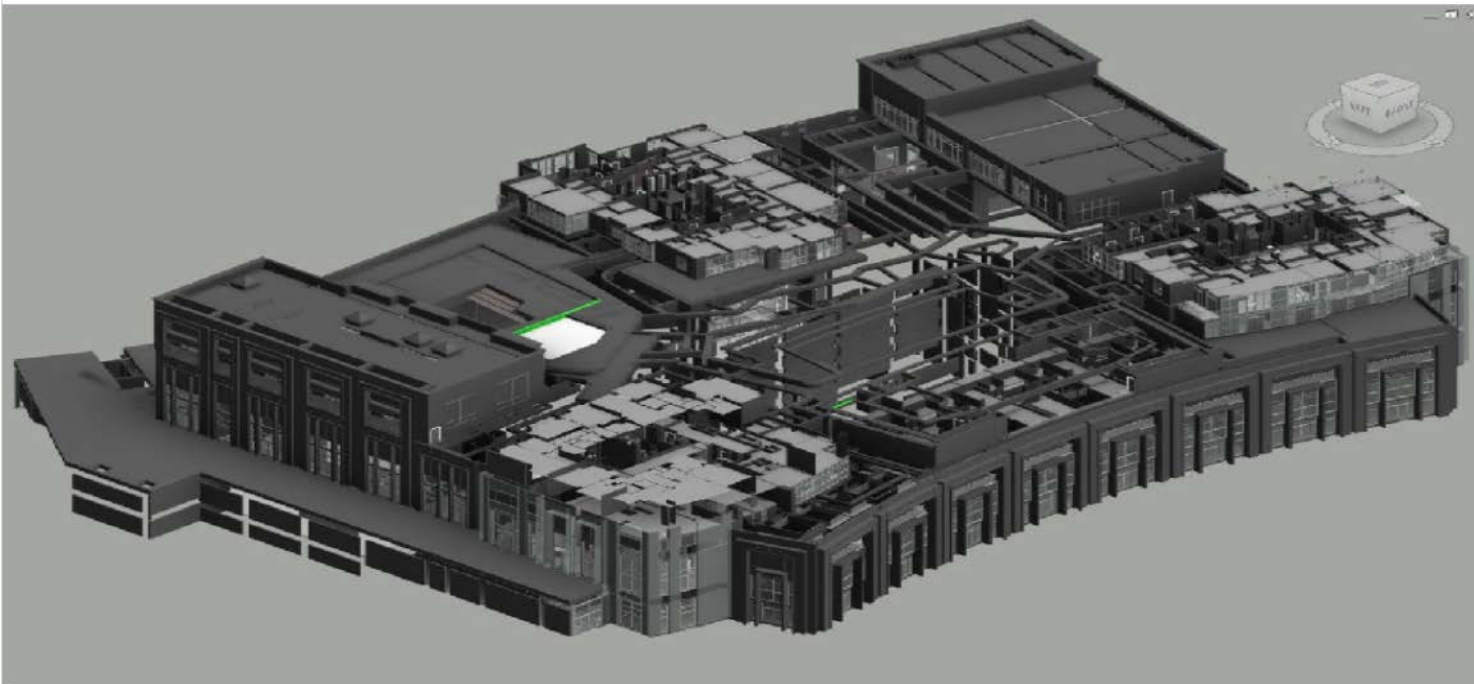

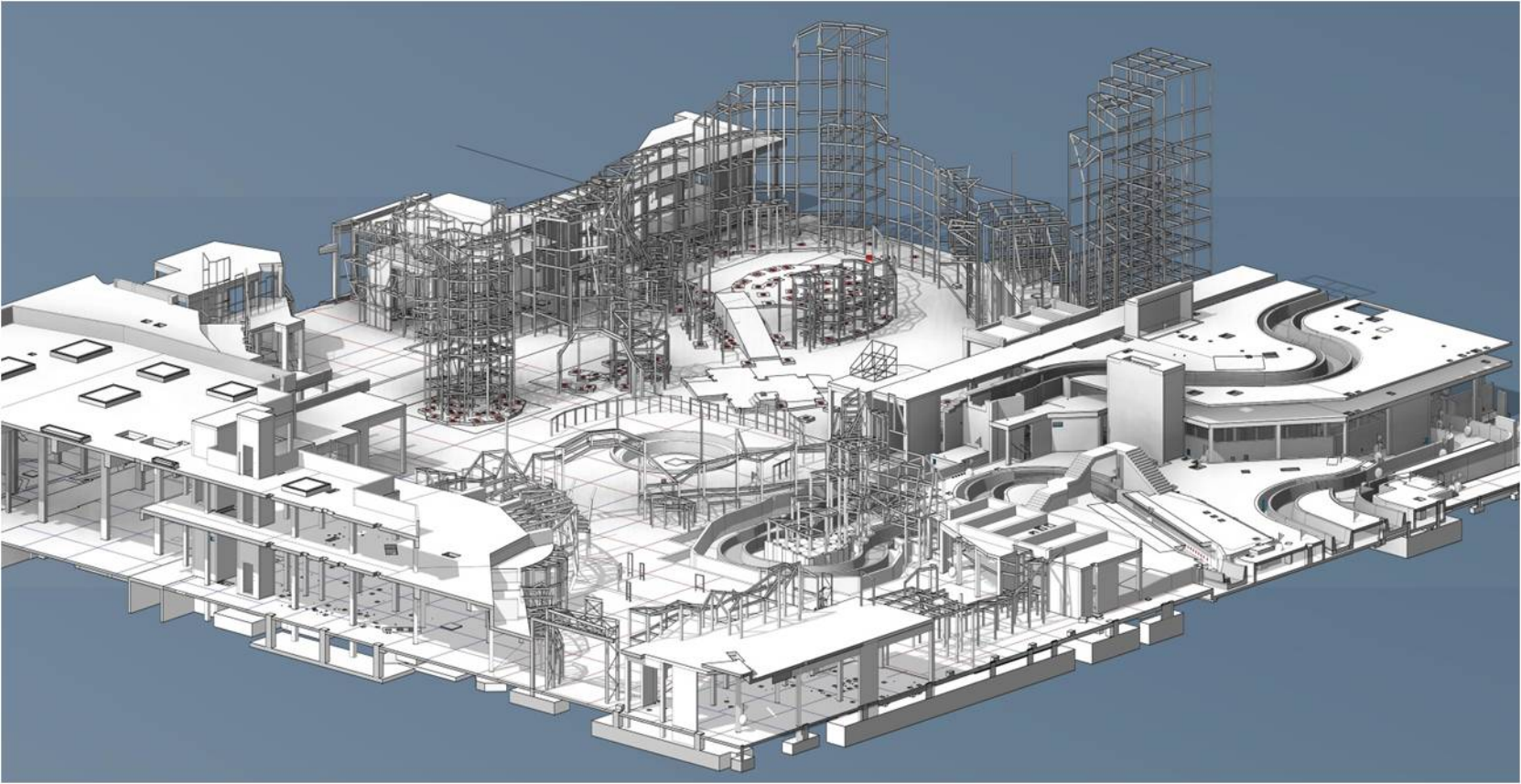

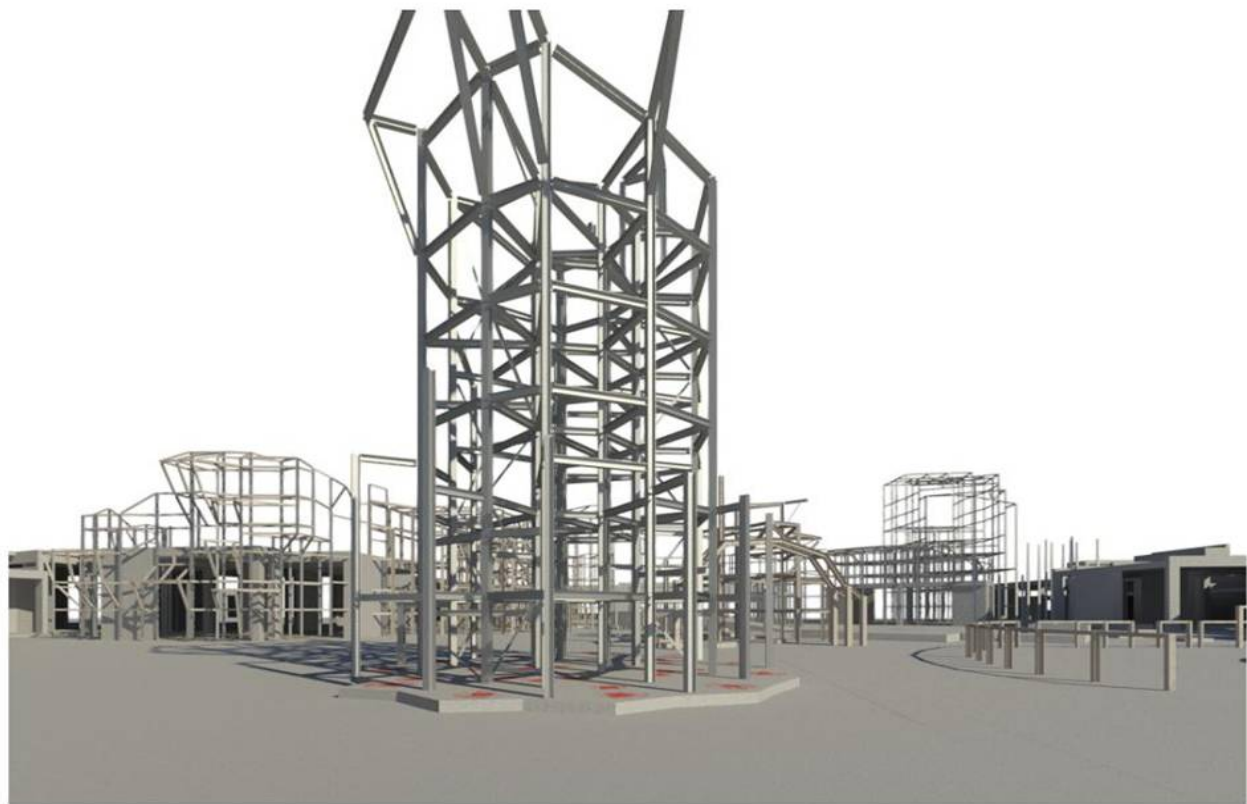

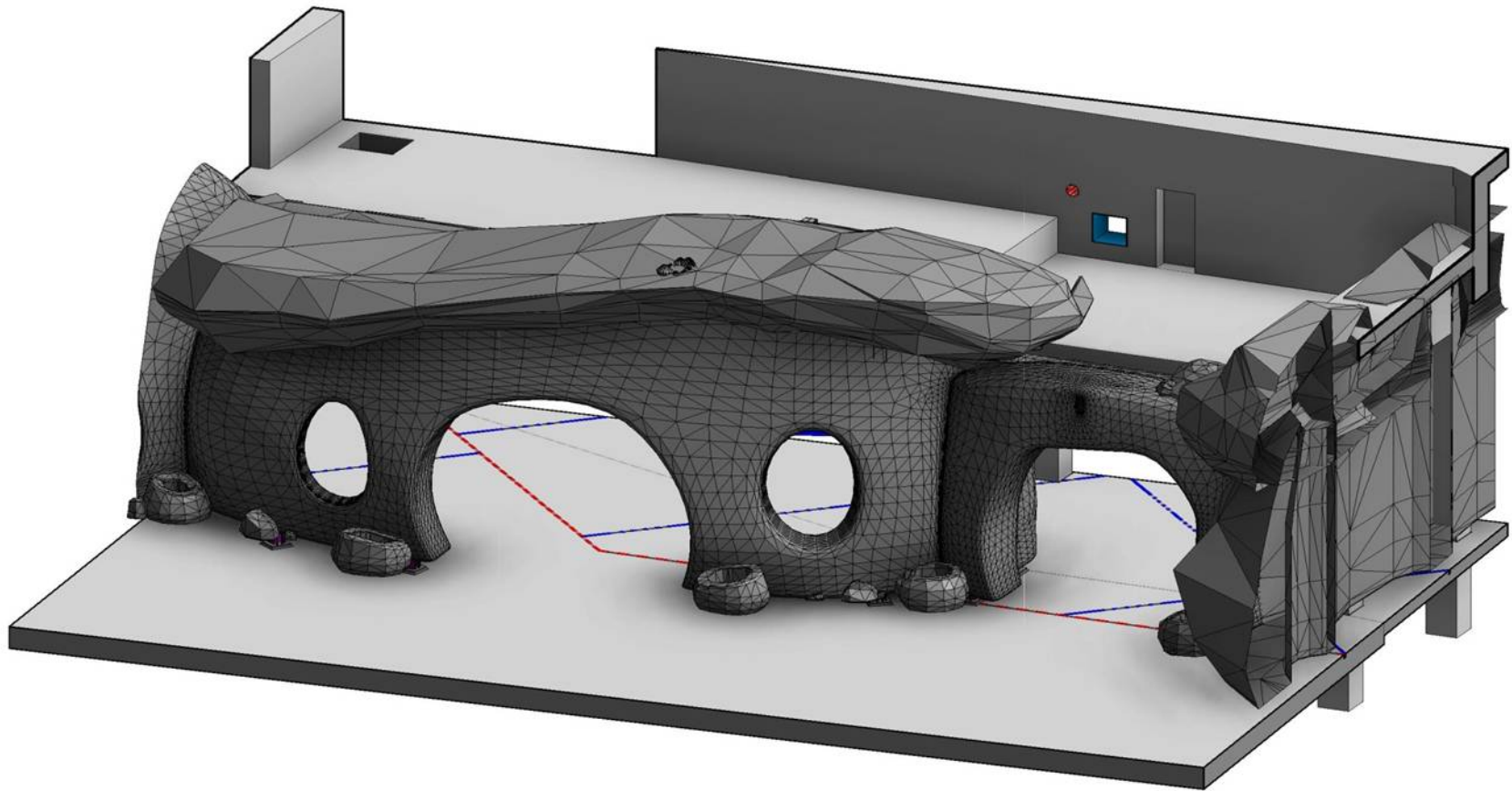

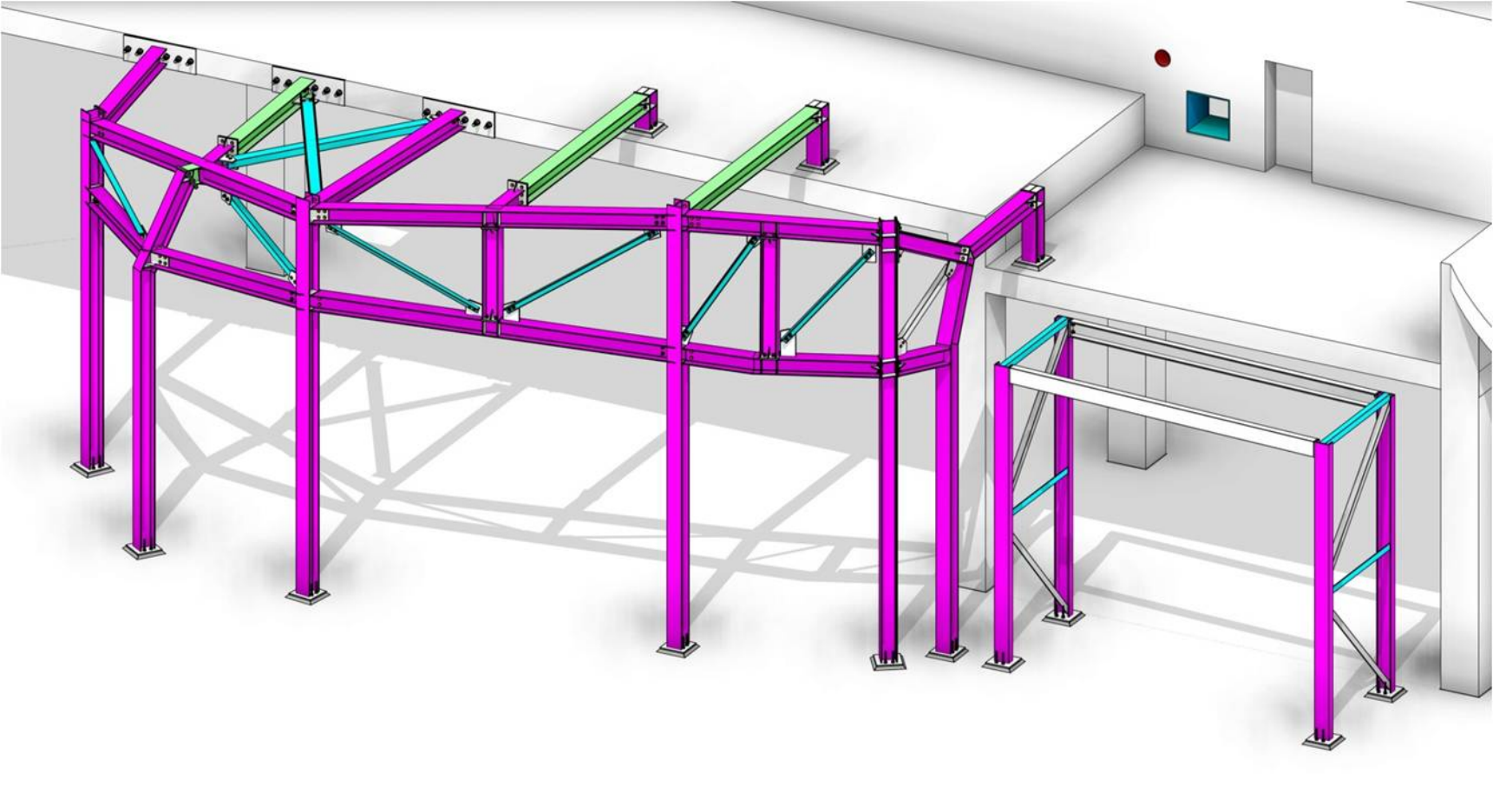

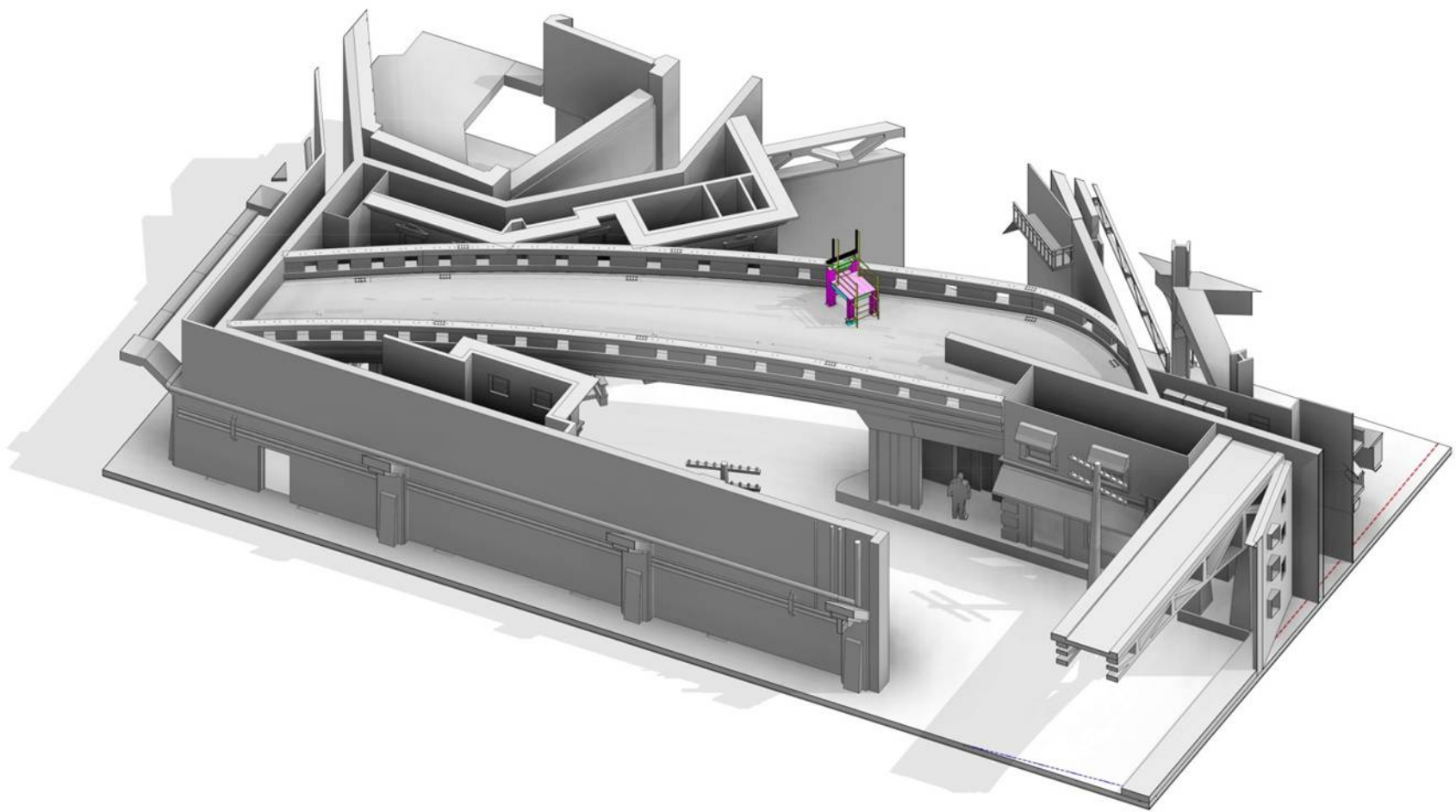



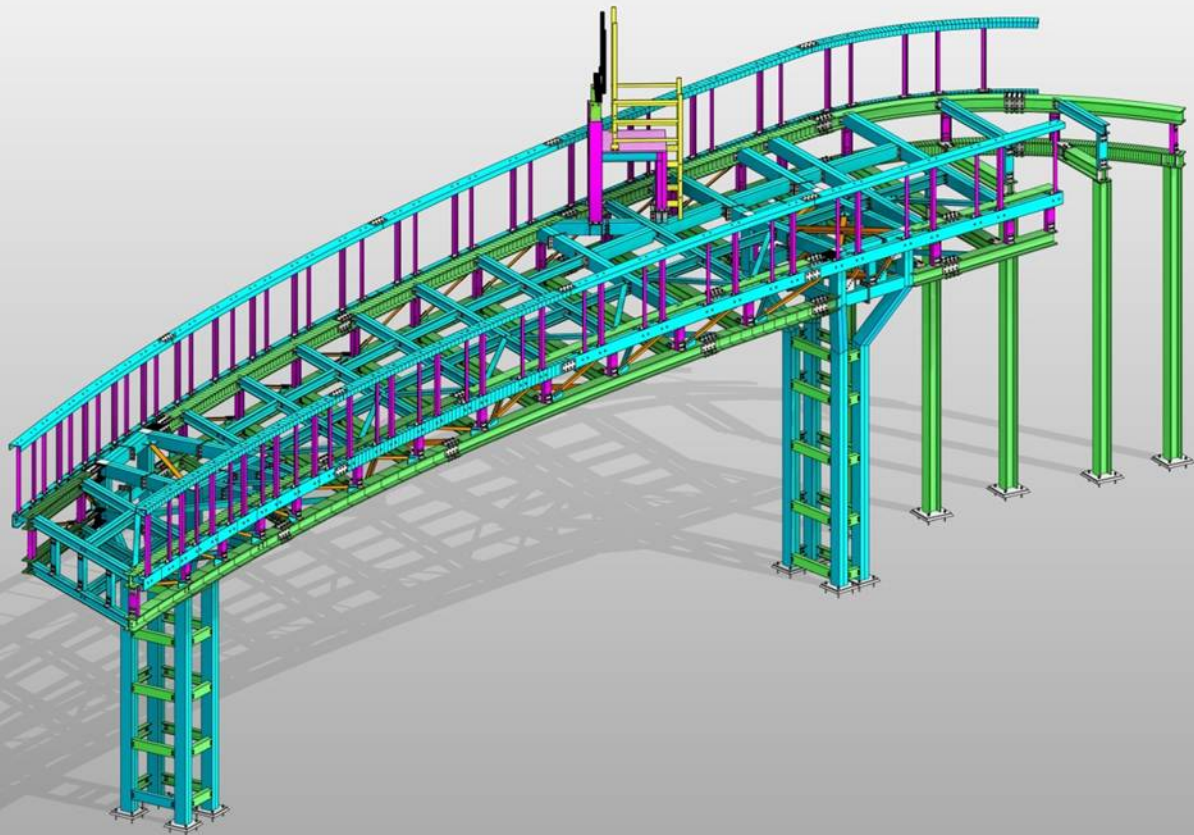

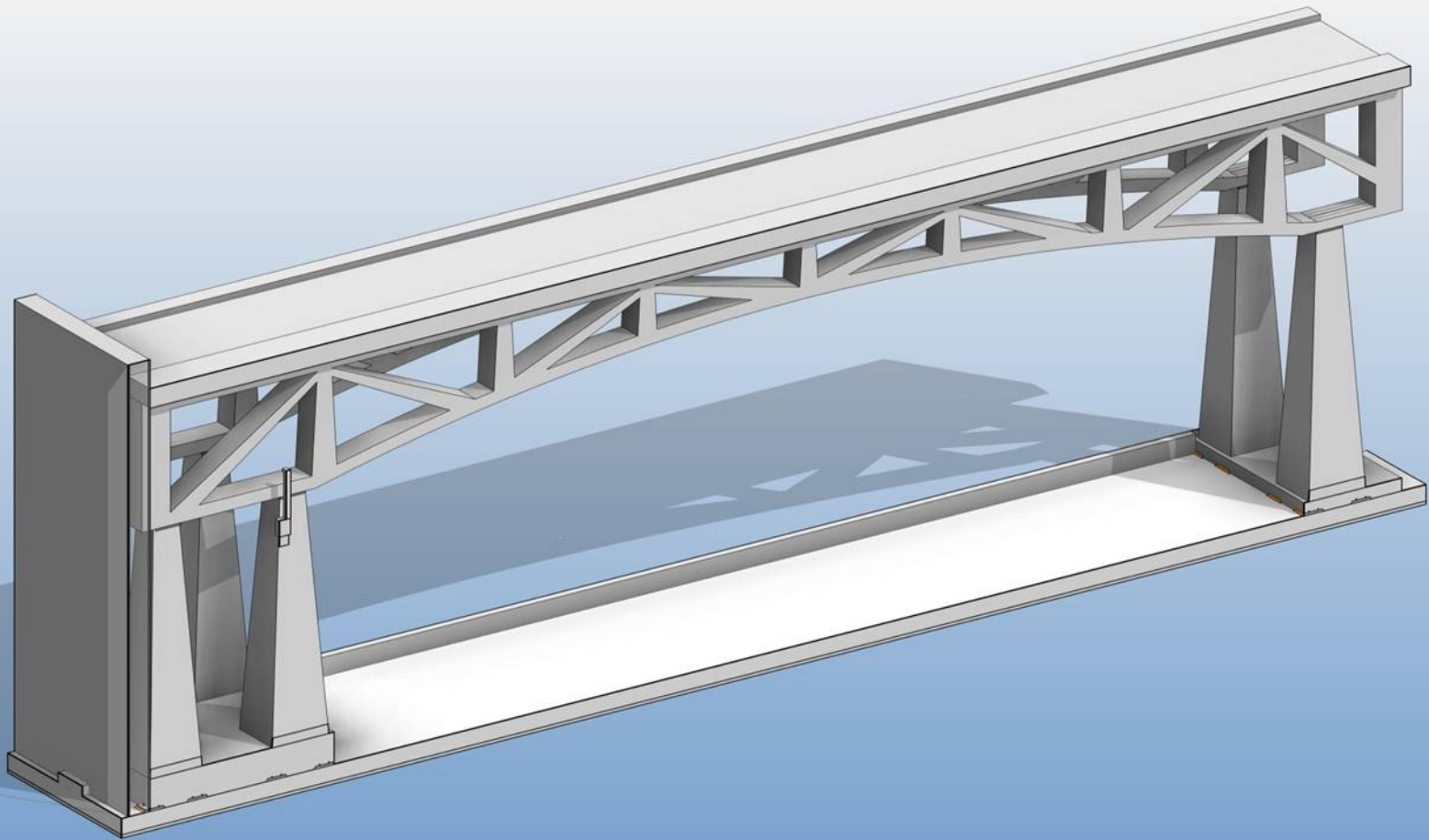

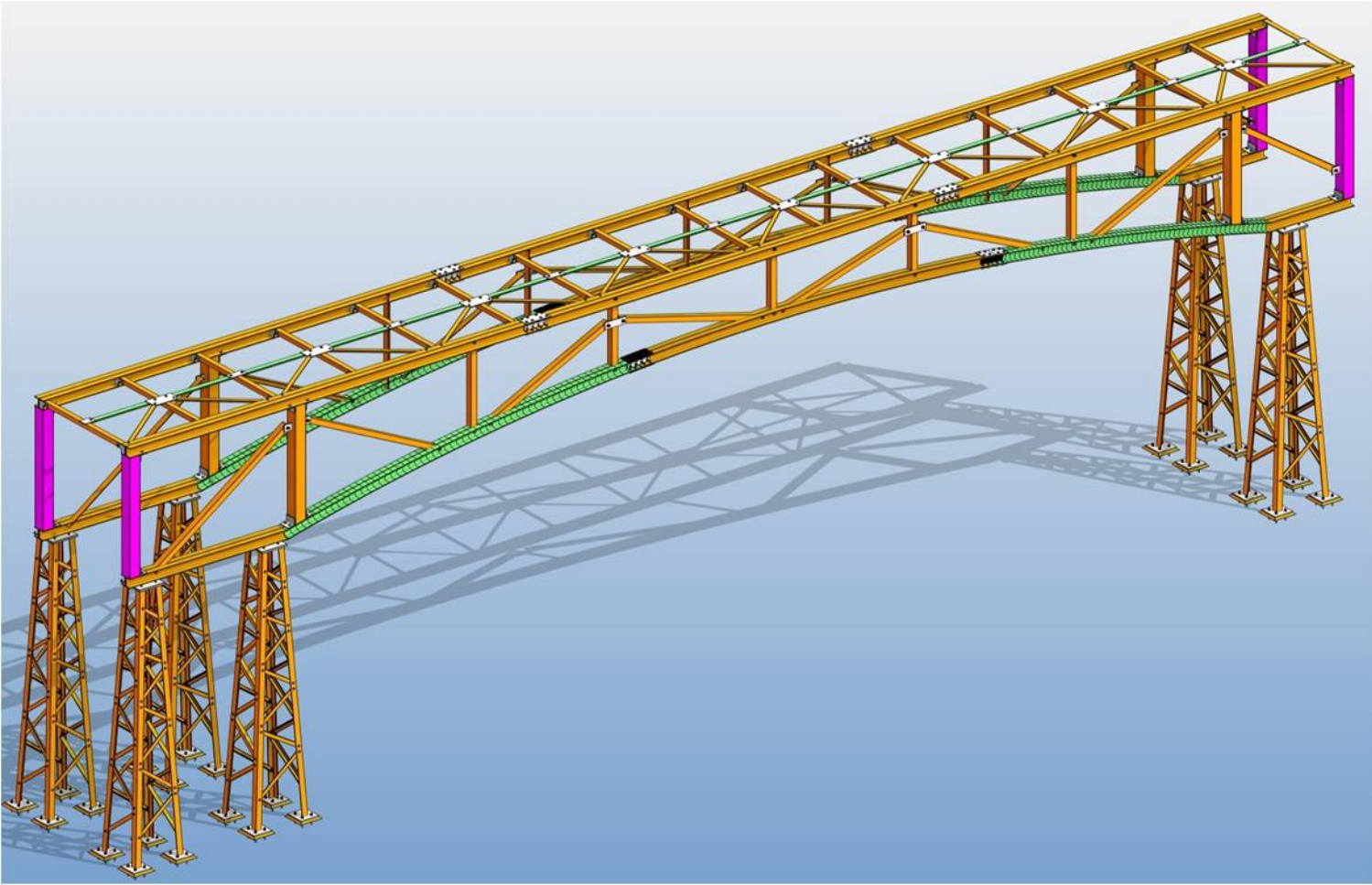

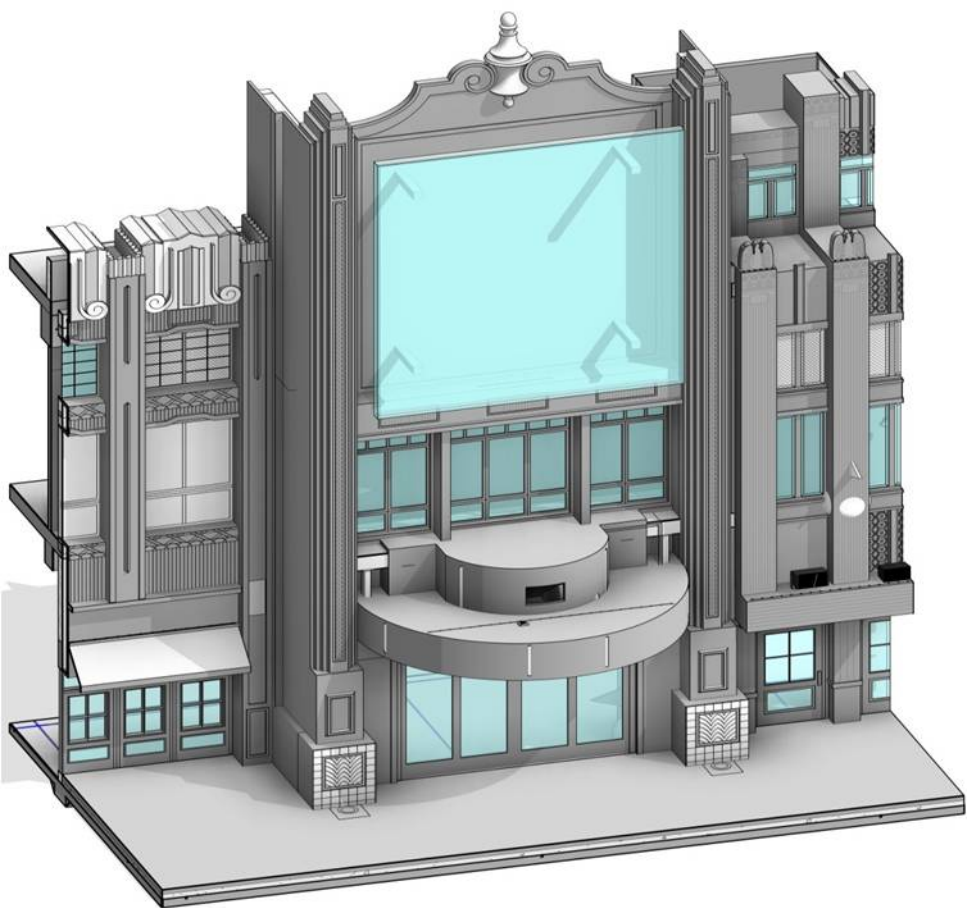

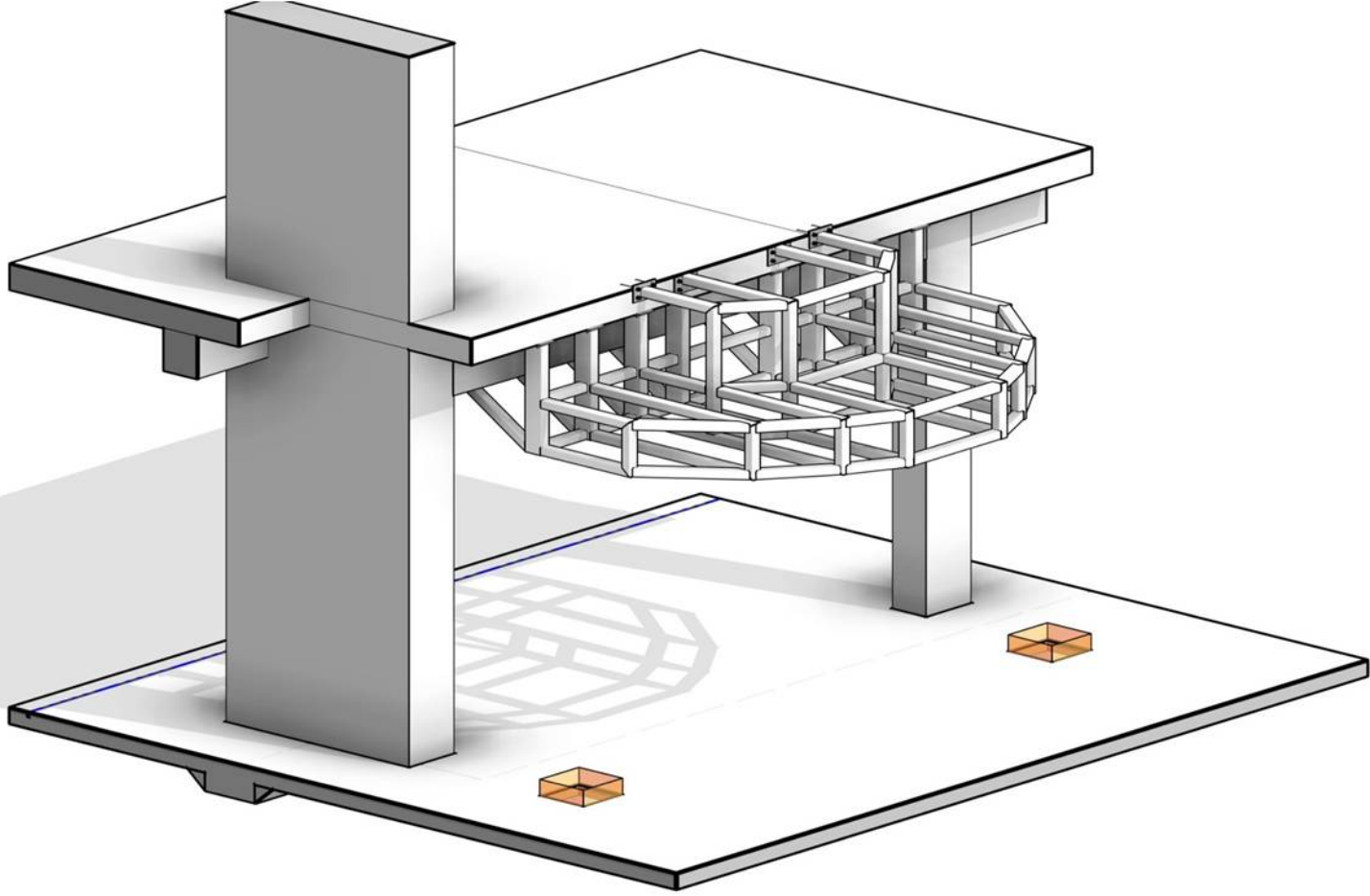

# ARCHITECTURE BIM SAMPLES



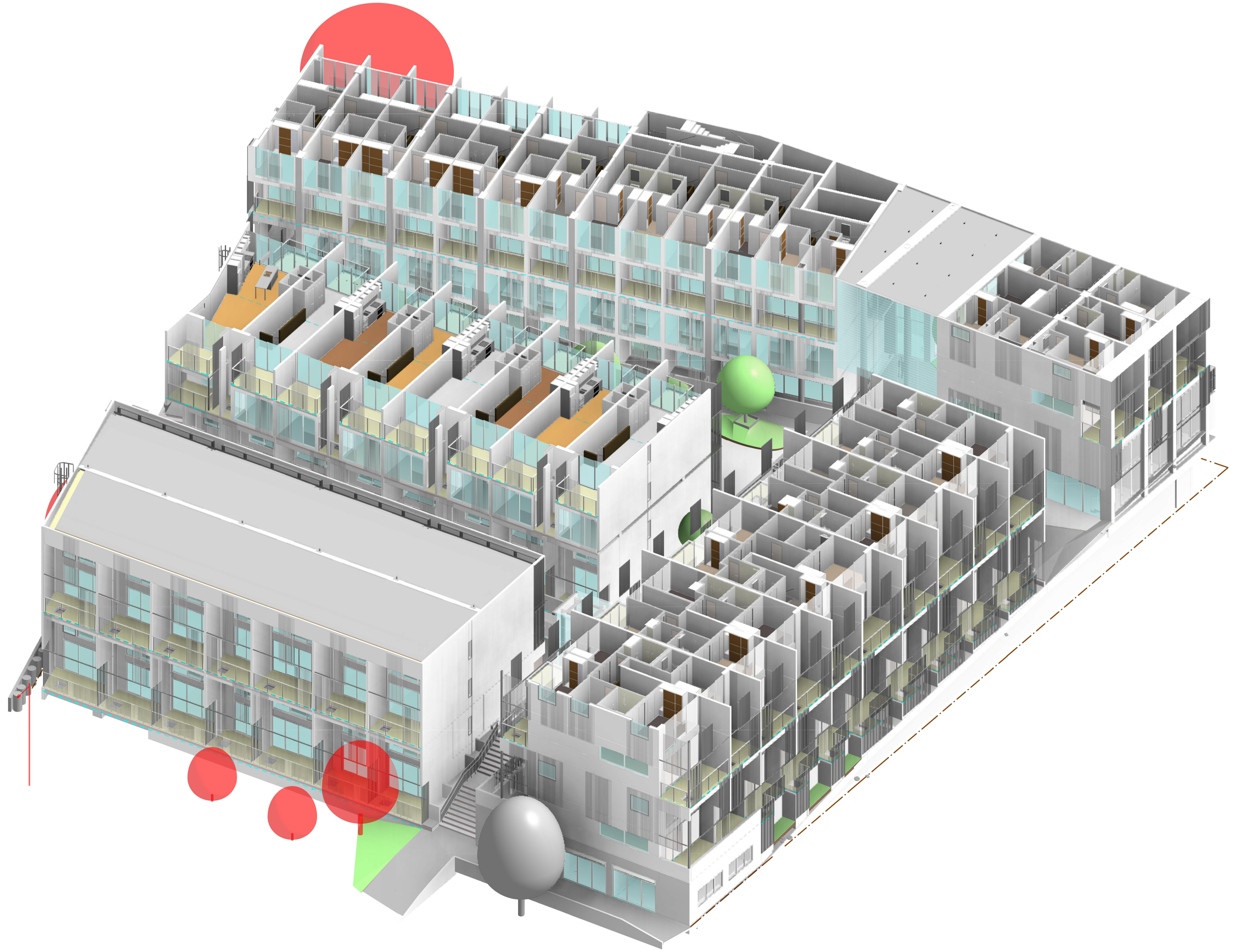







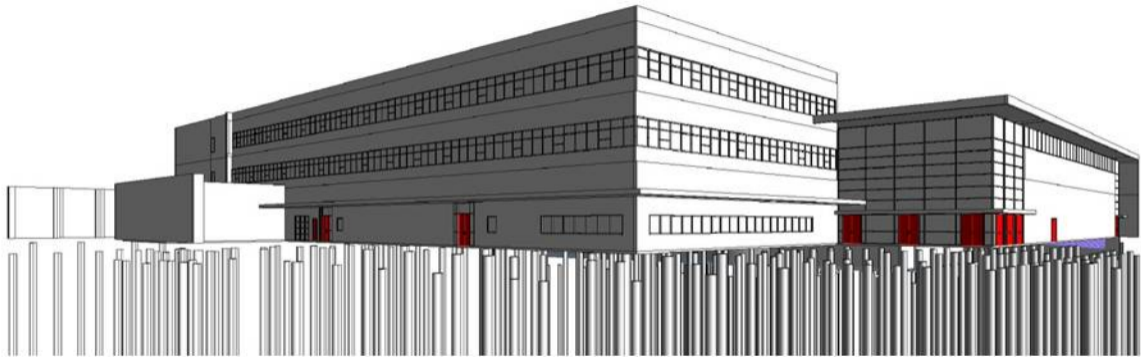

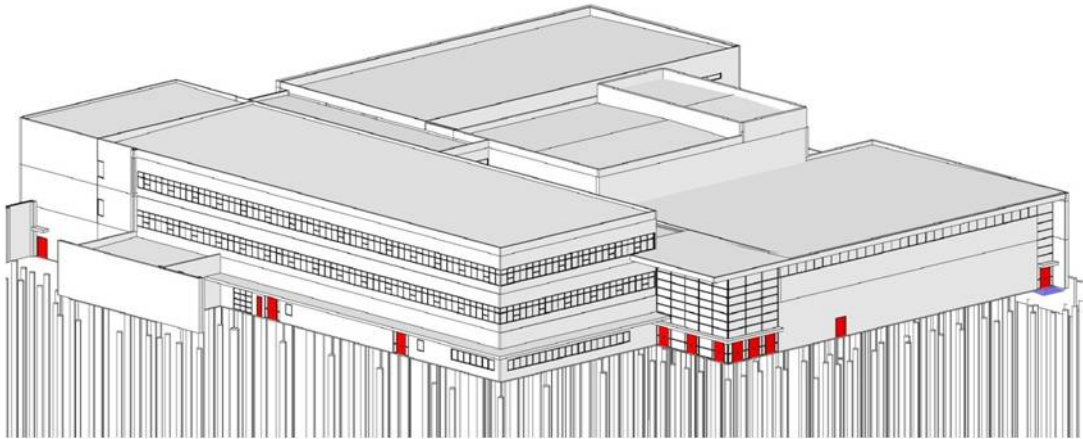

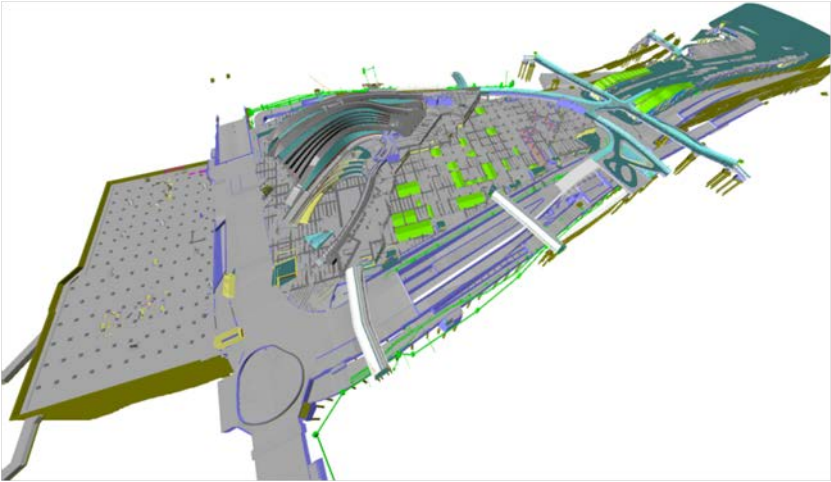





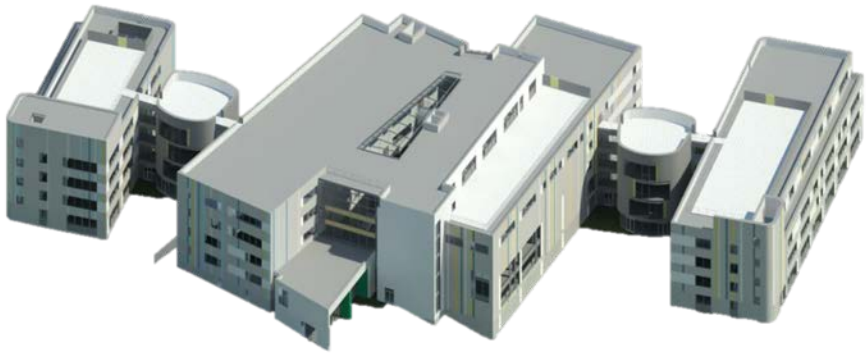







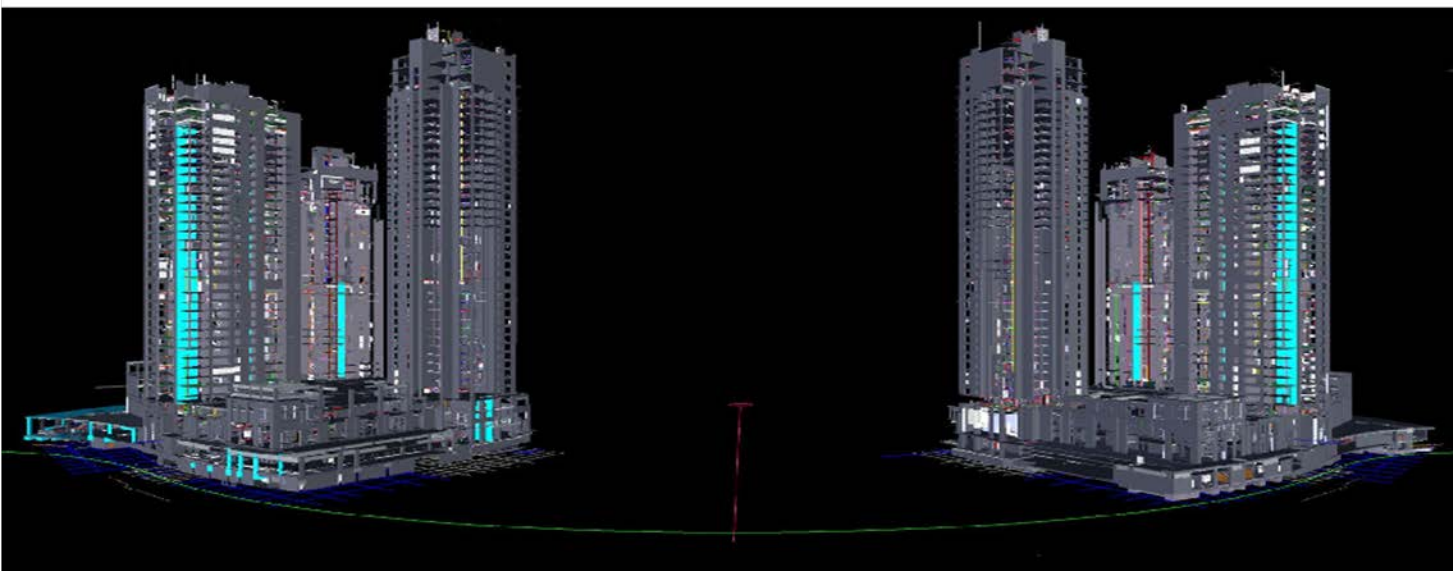









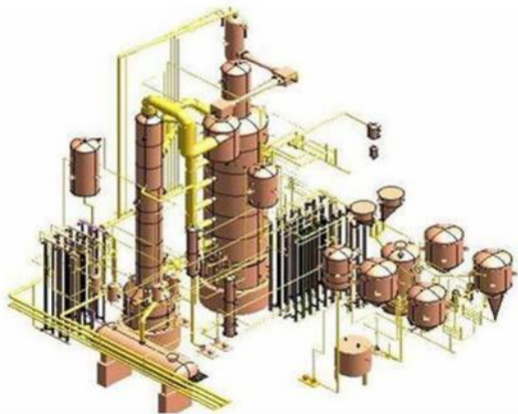



# INFRASTRUCTURE BIM SAMPLES

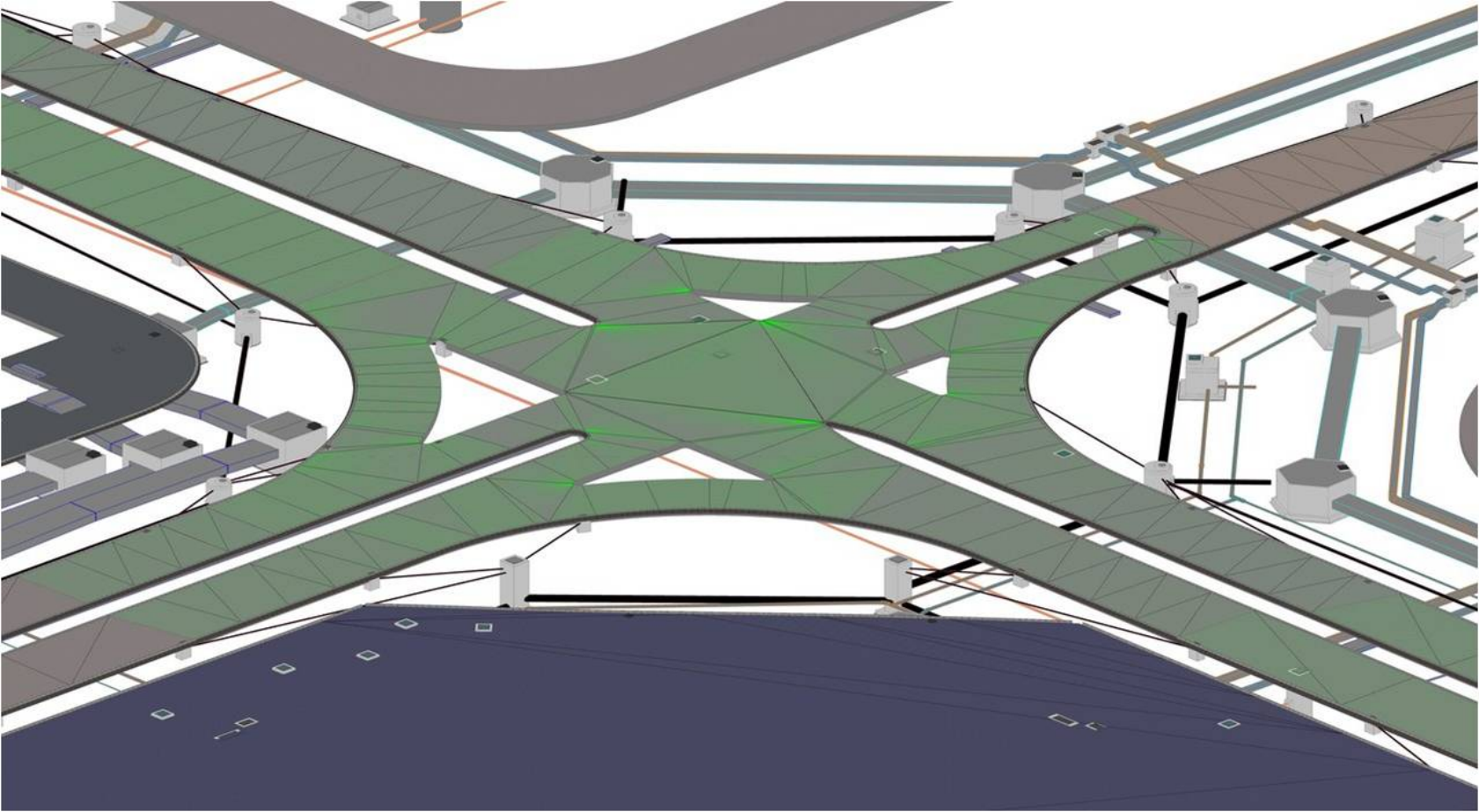

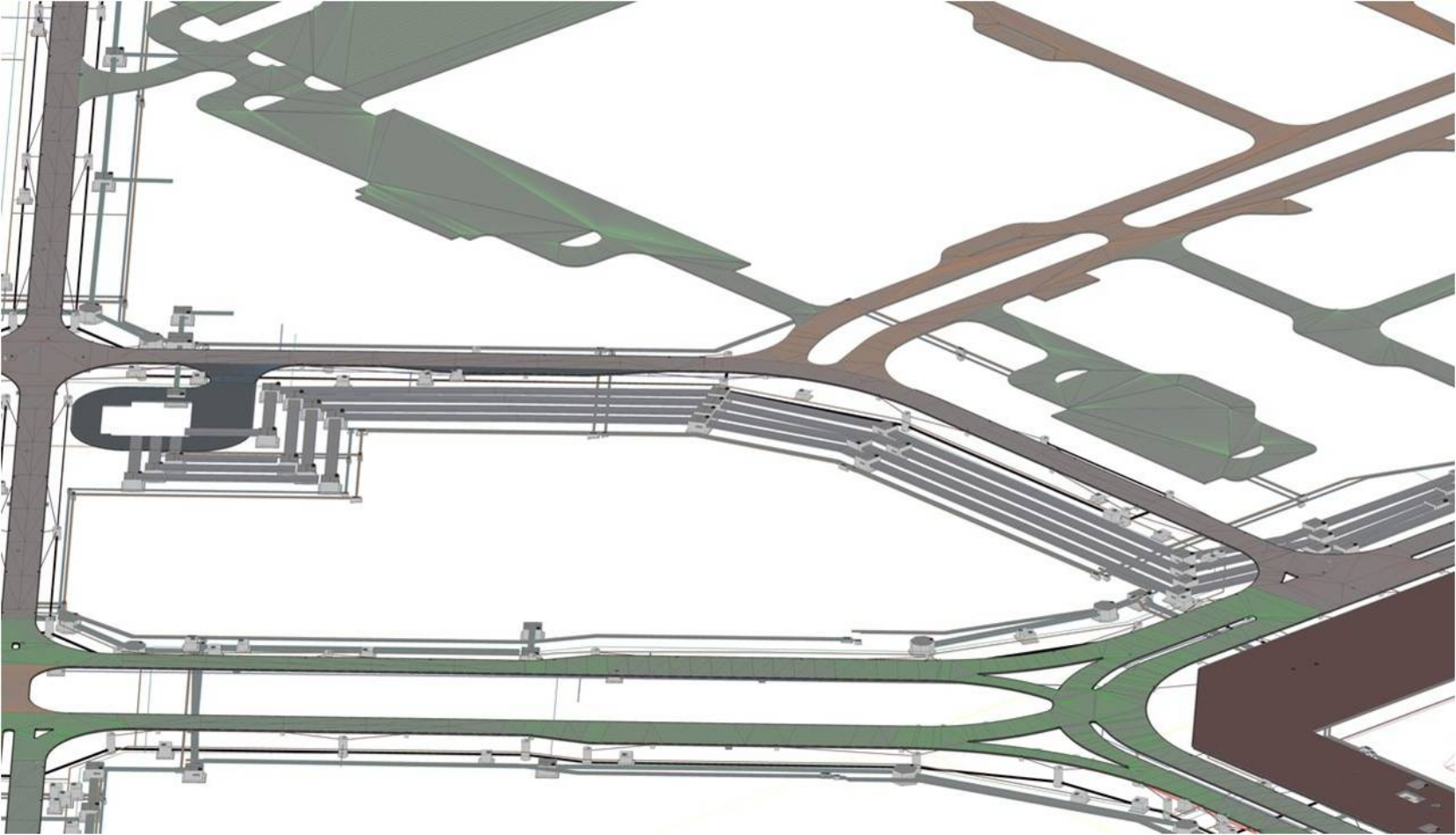

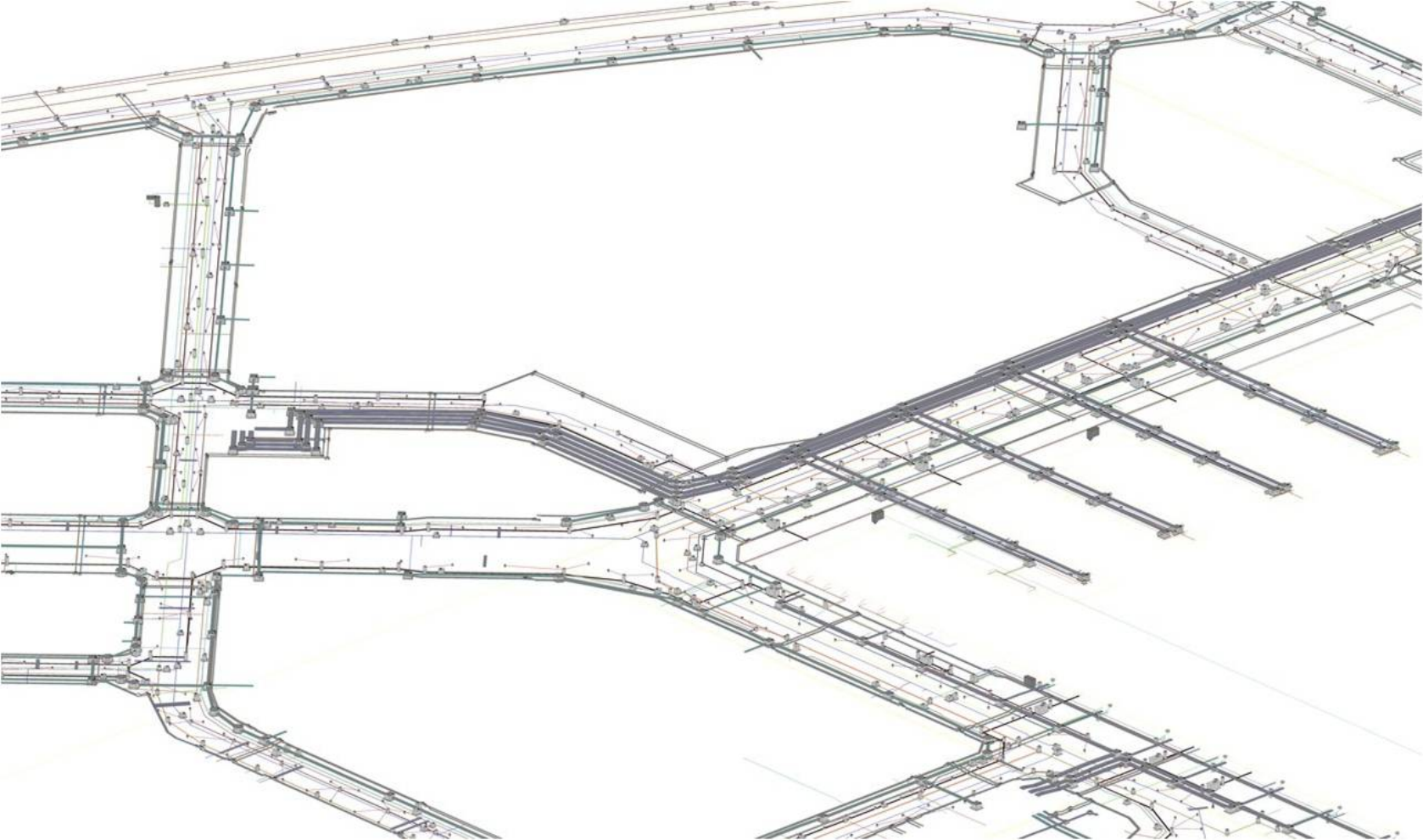



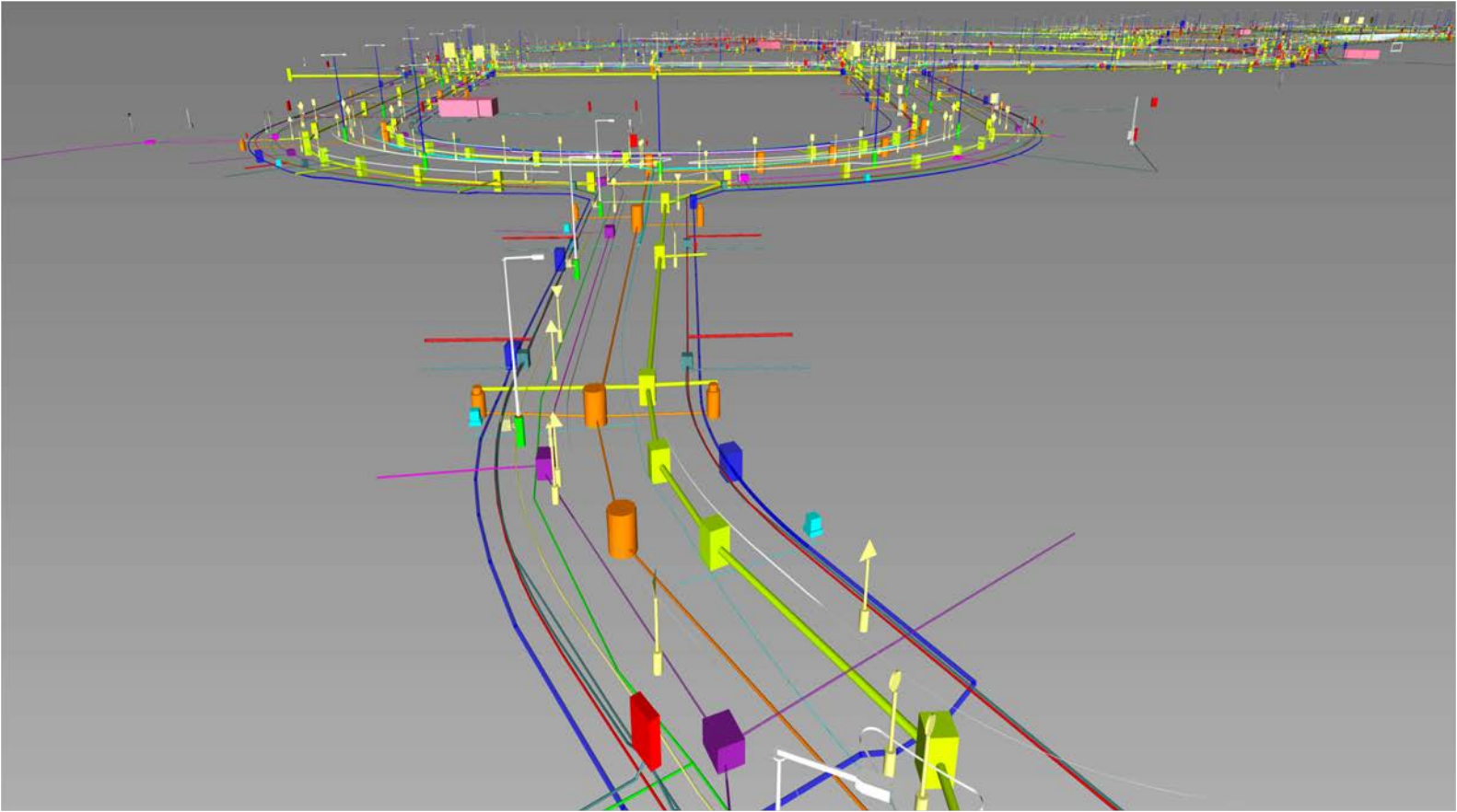

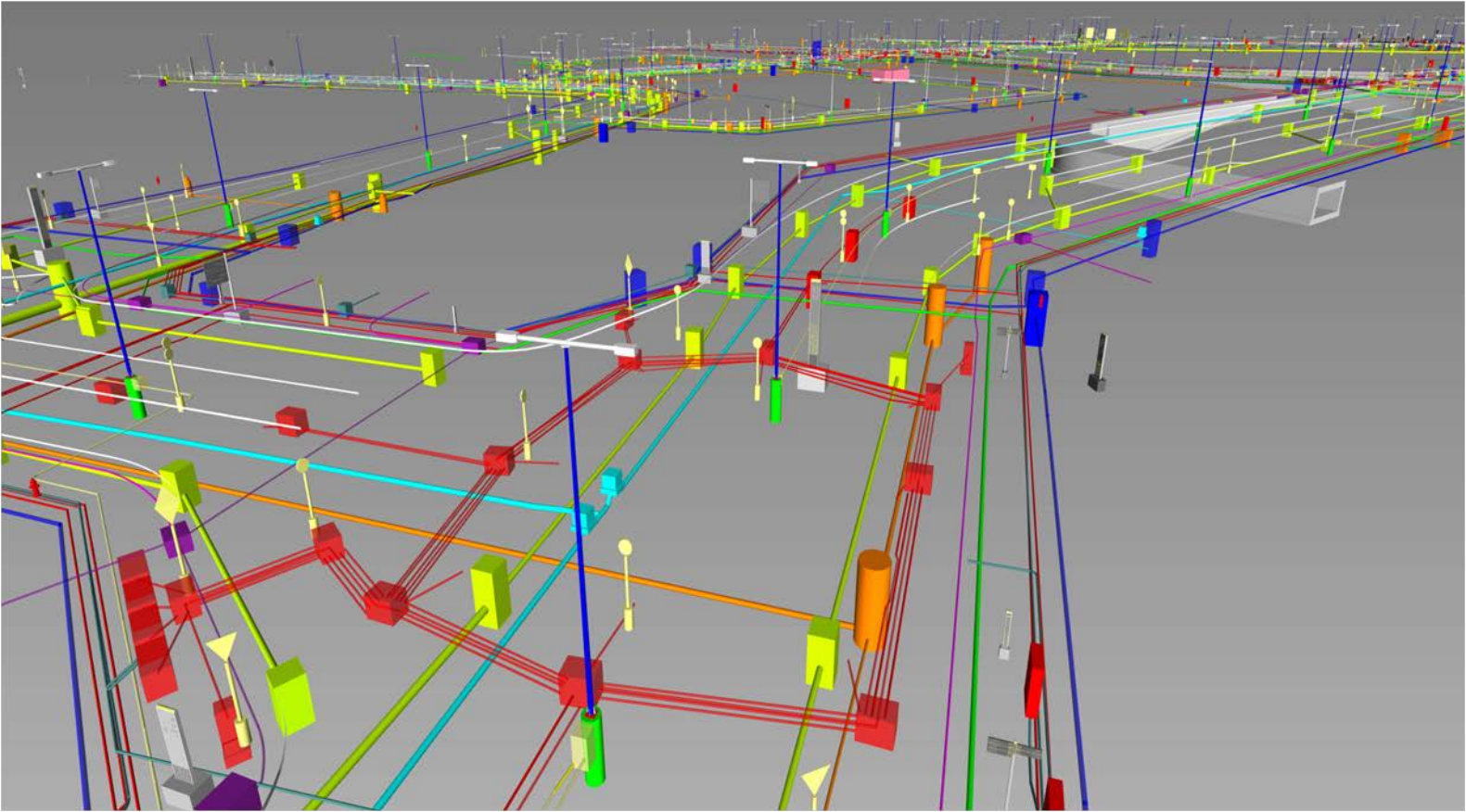

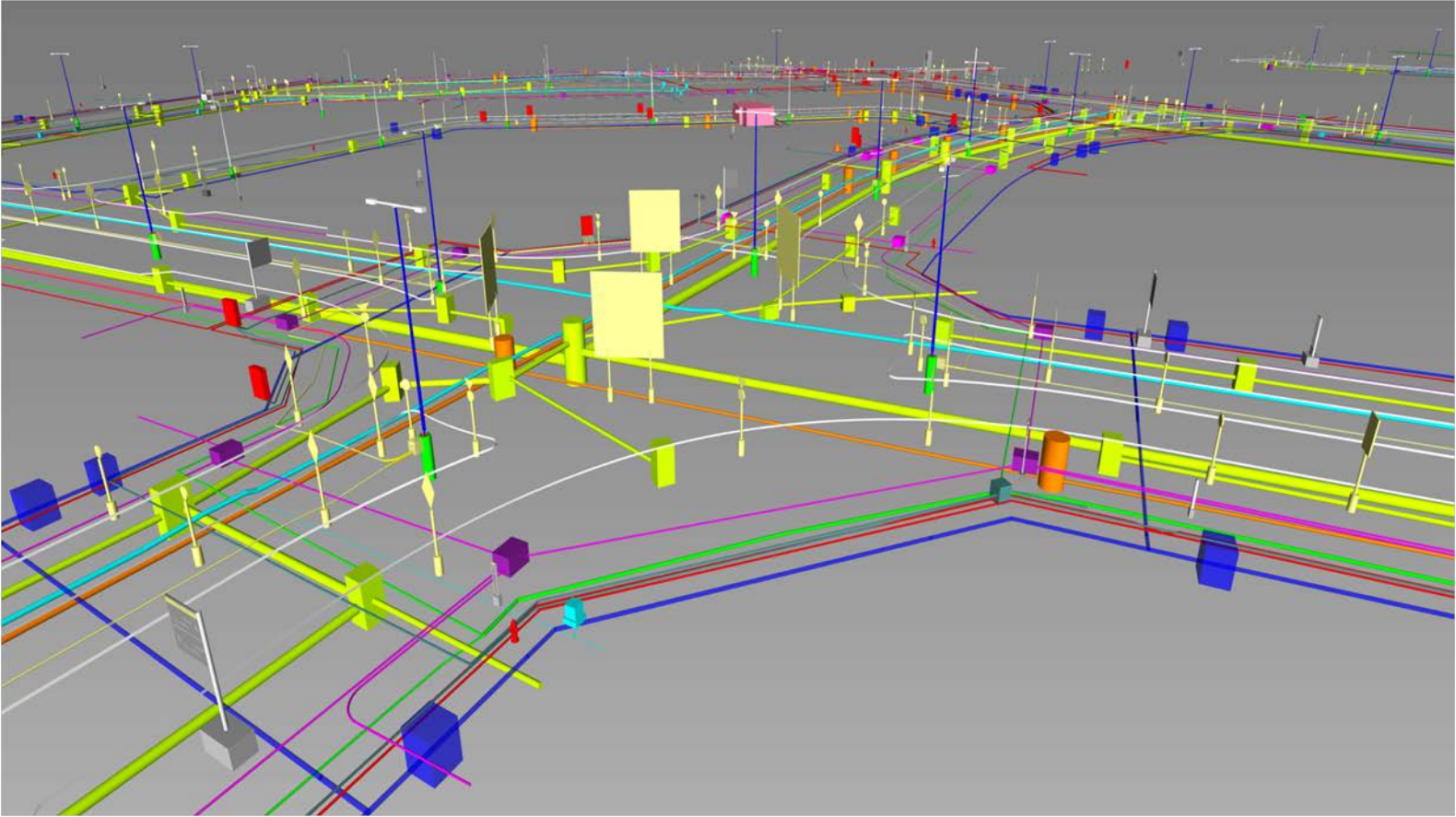



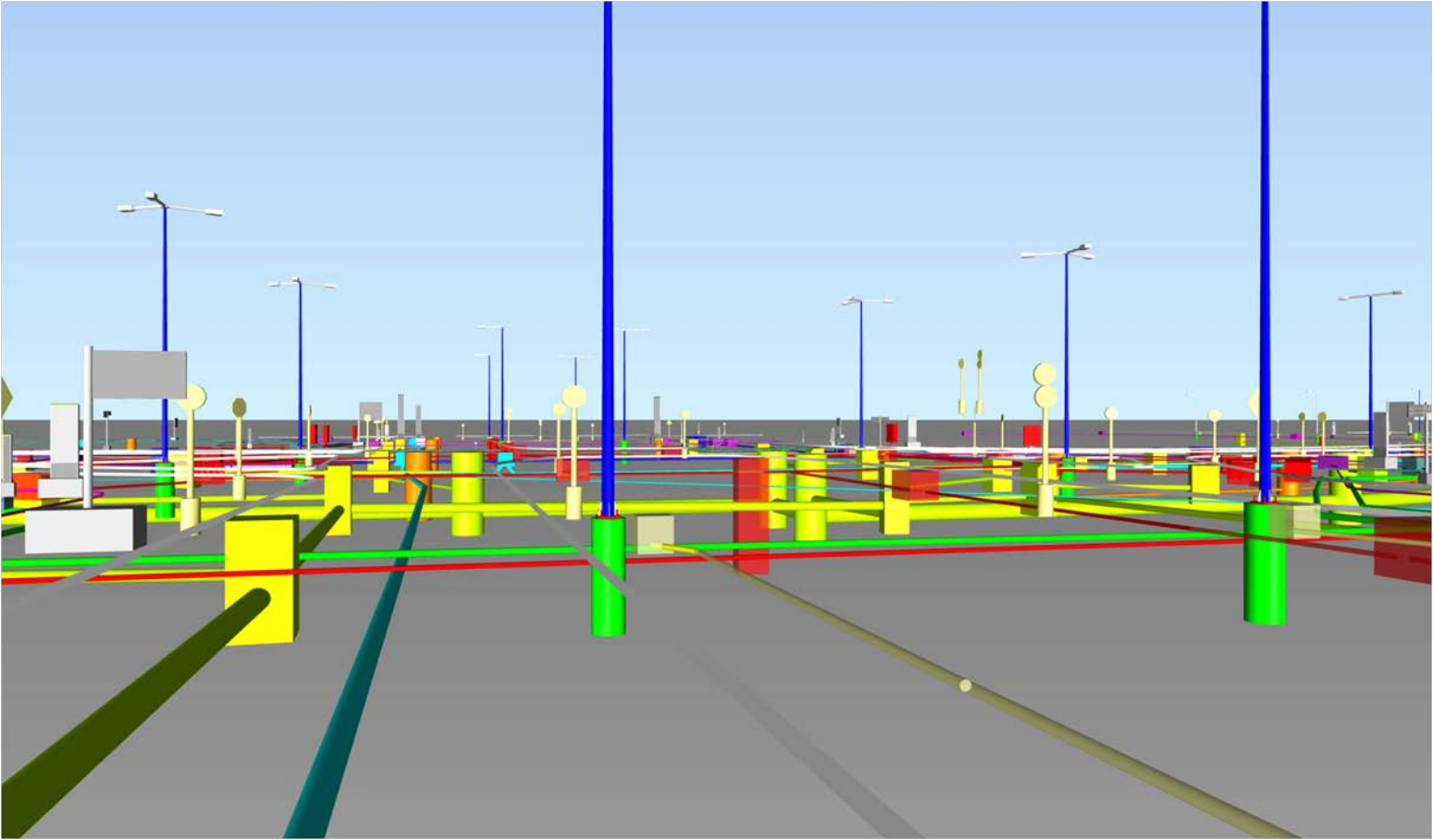

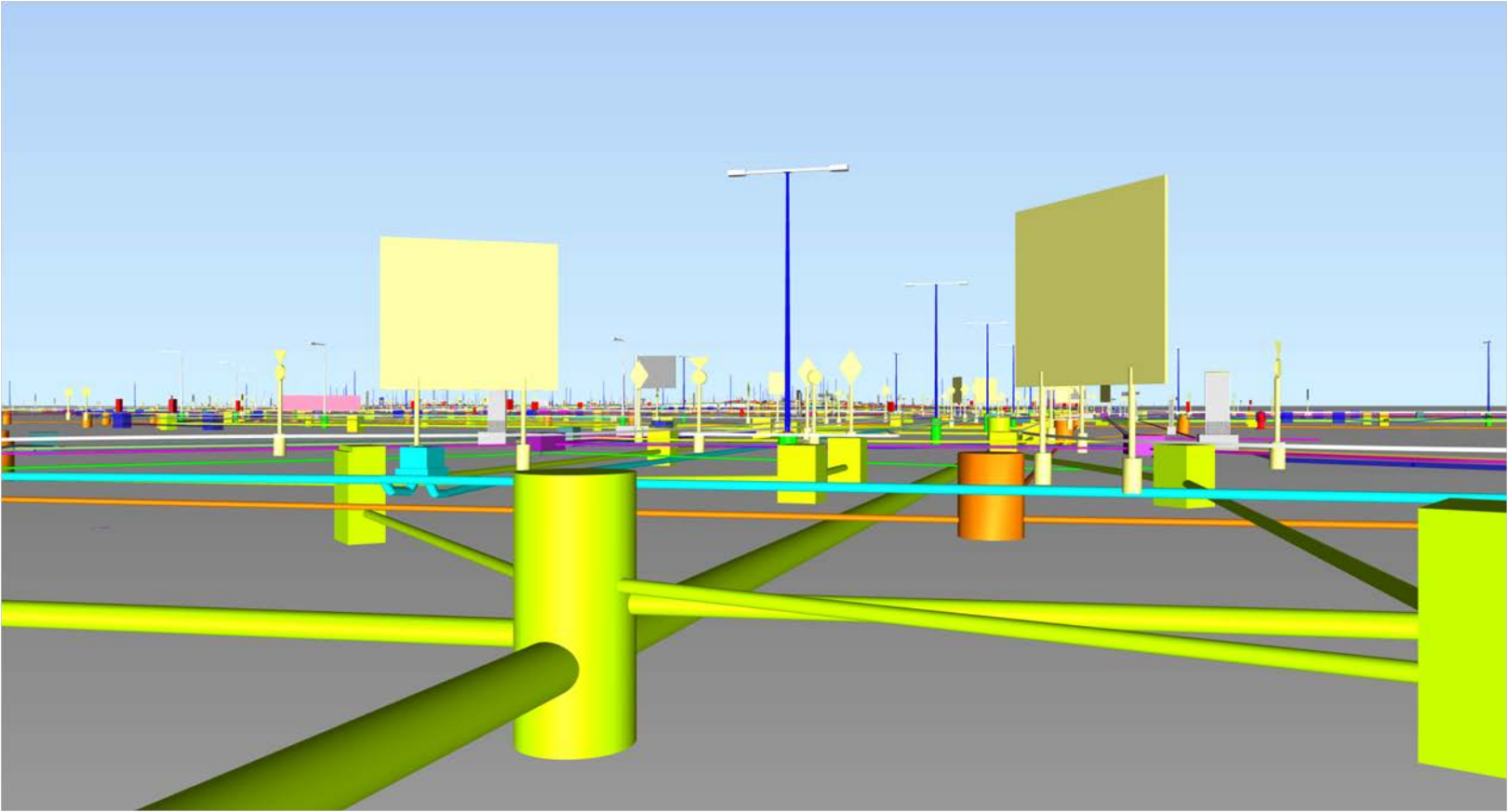

# MEPF BIM SAMPLES

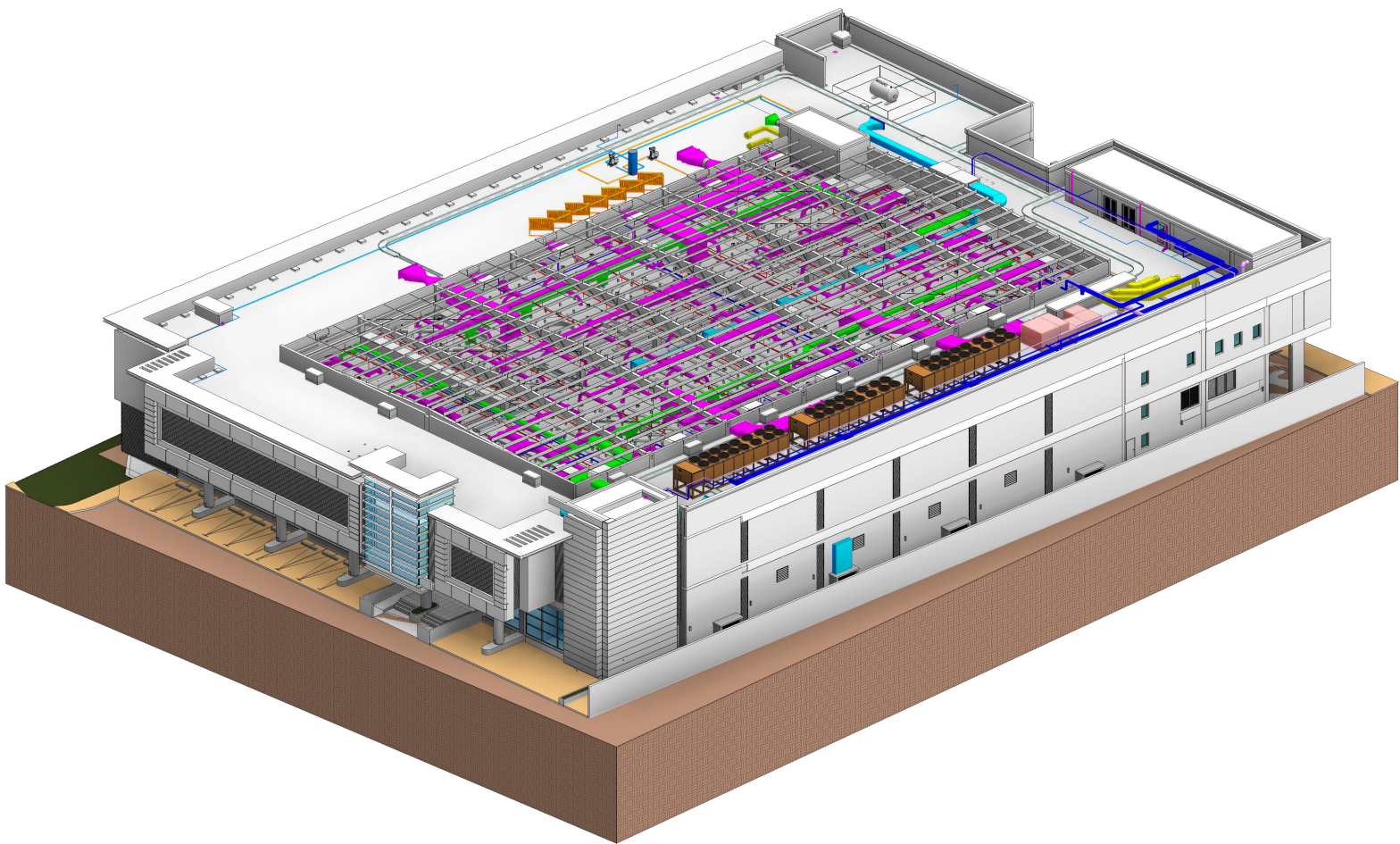

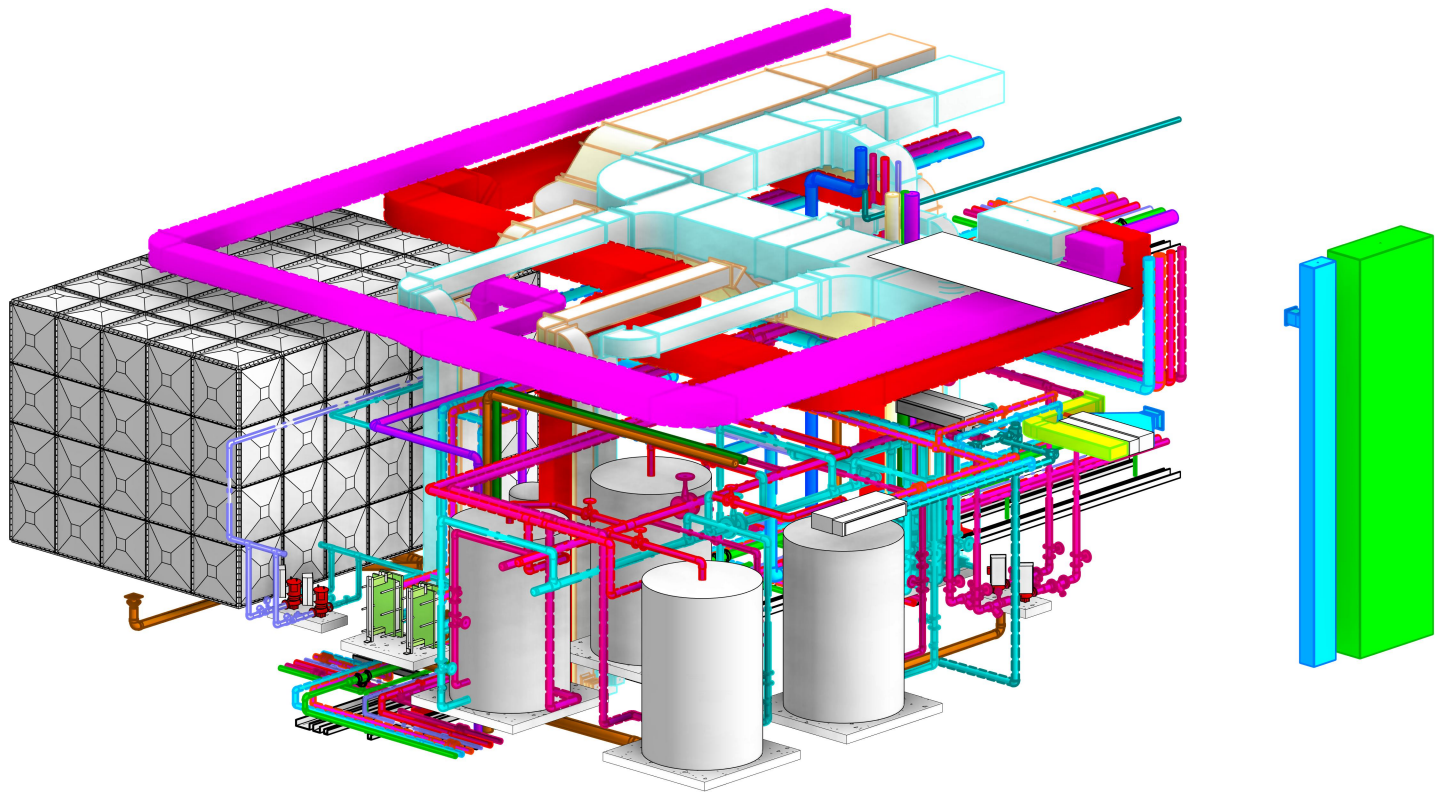

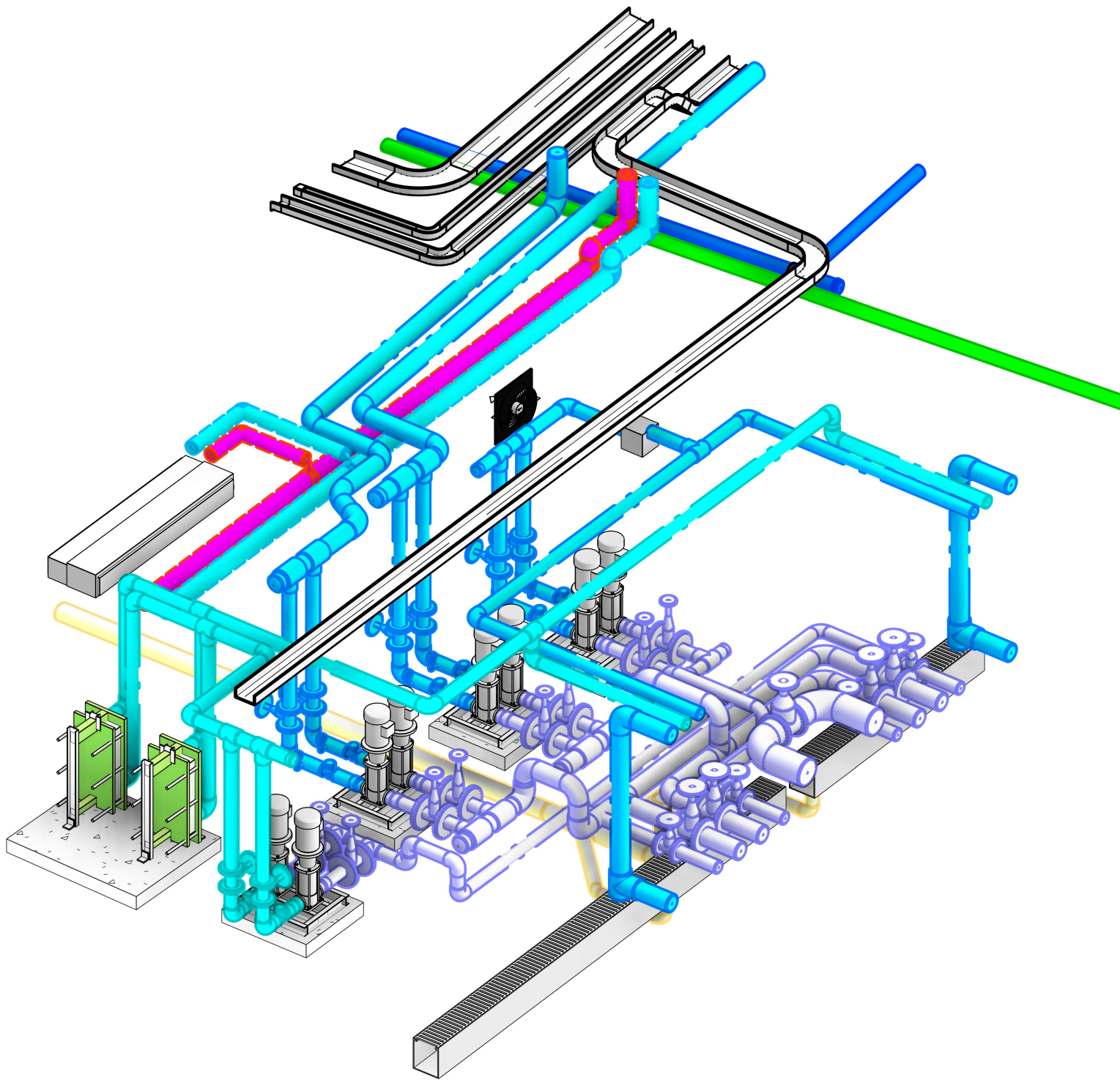

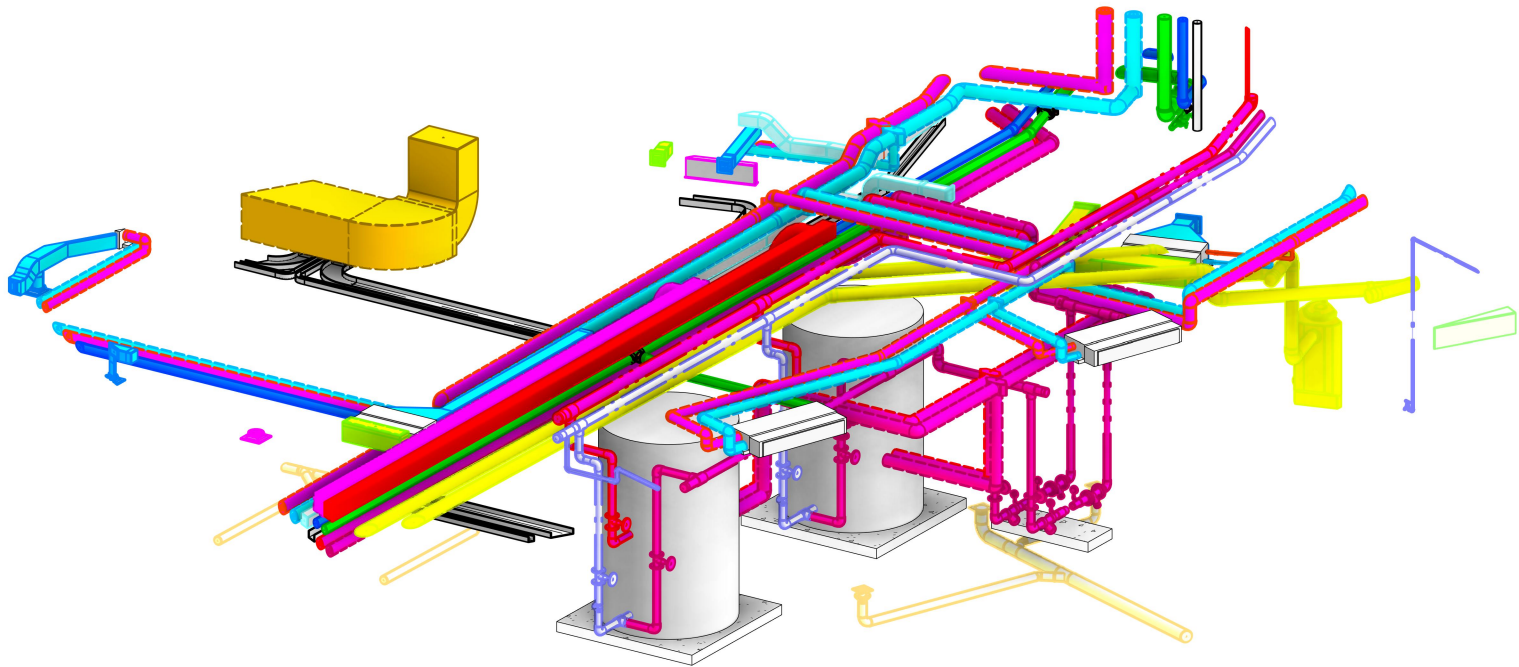

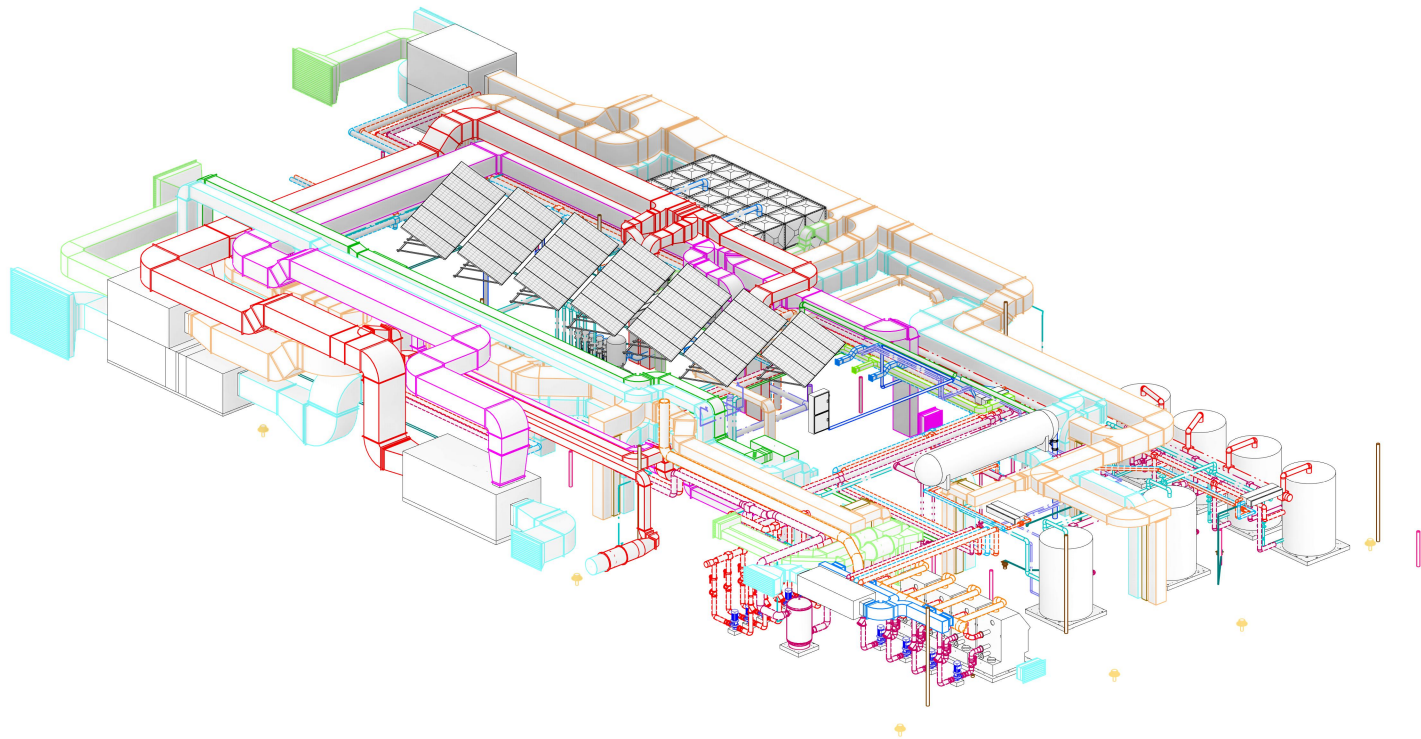



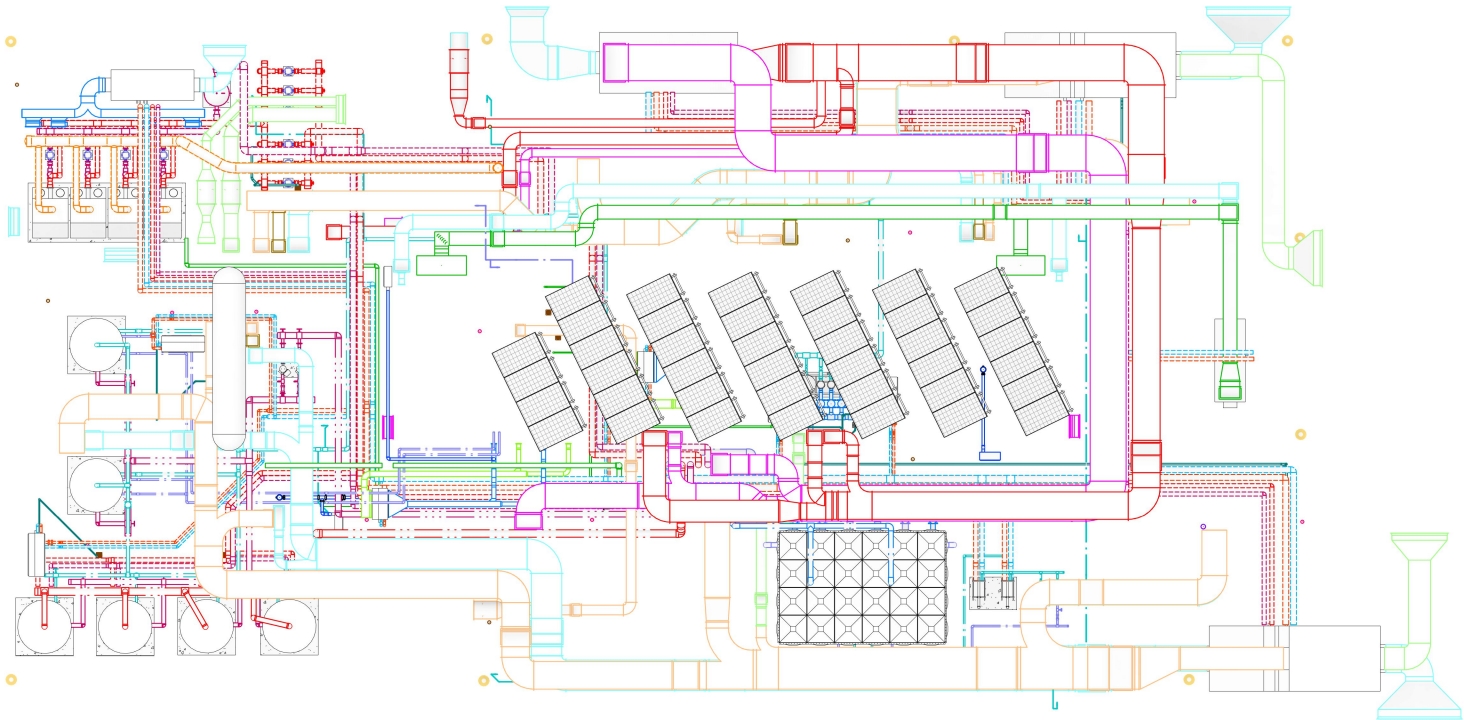

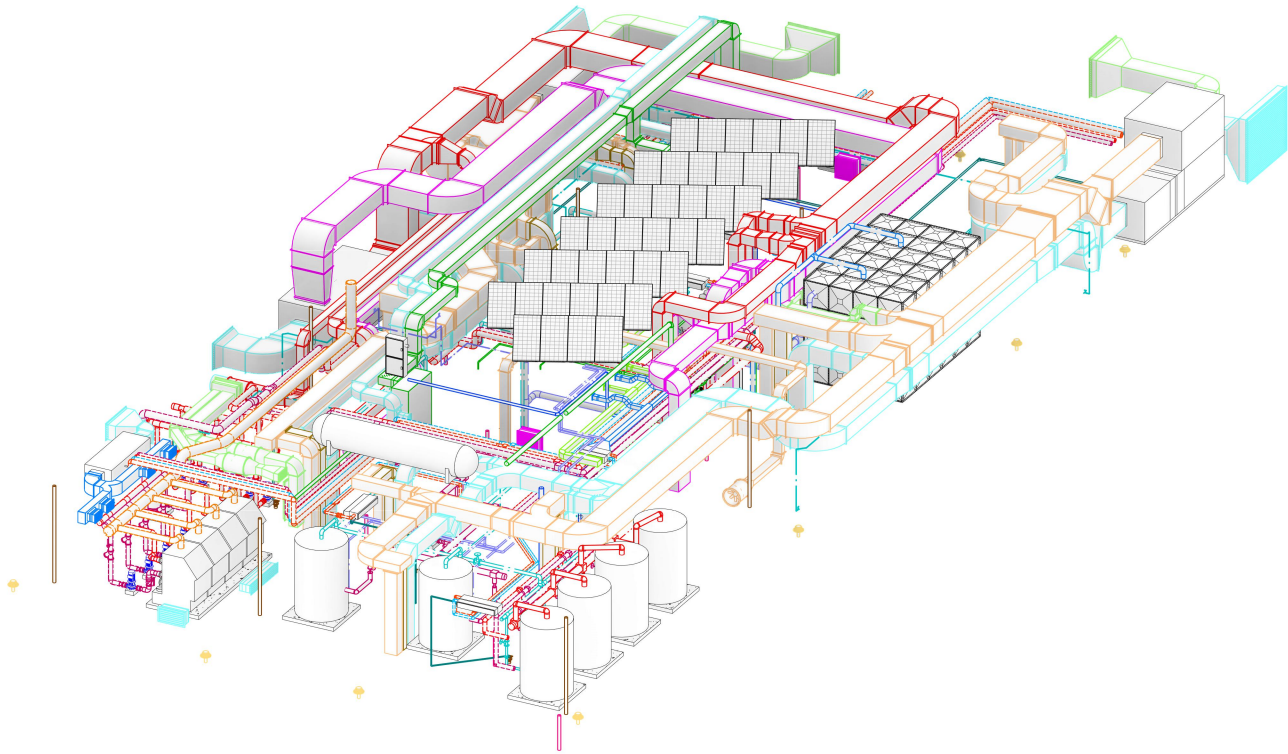



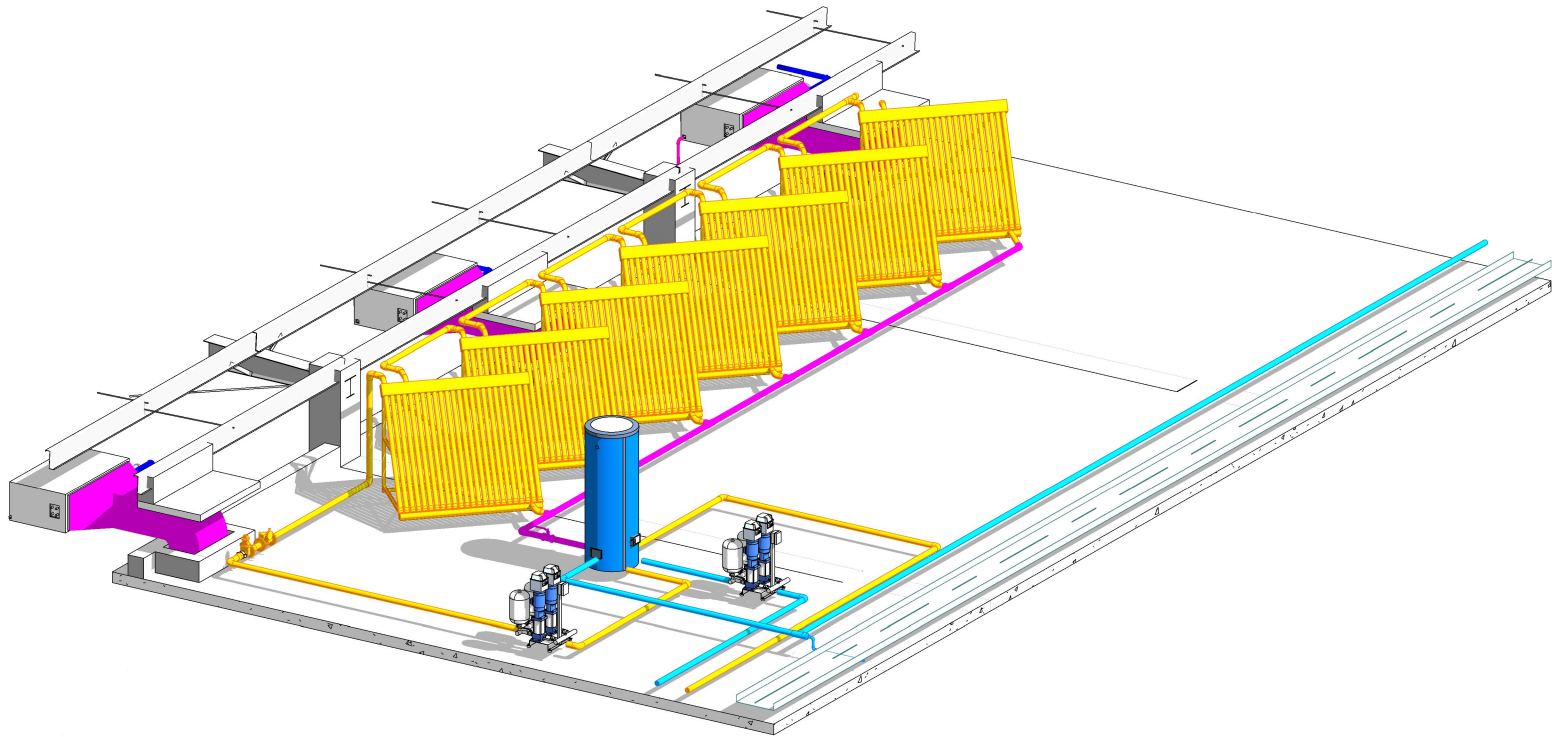





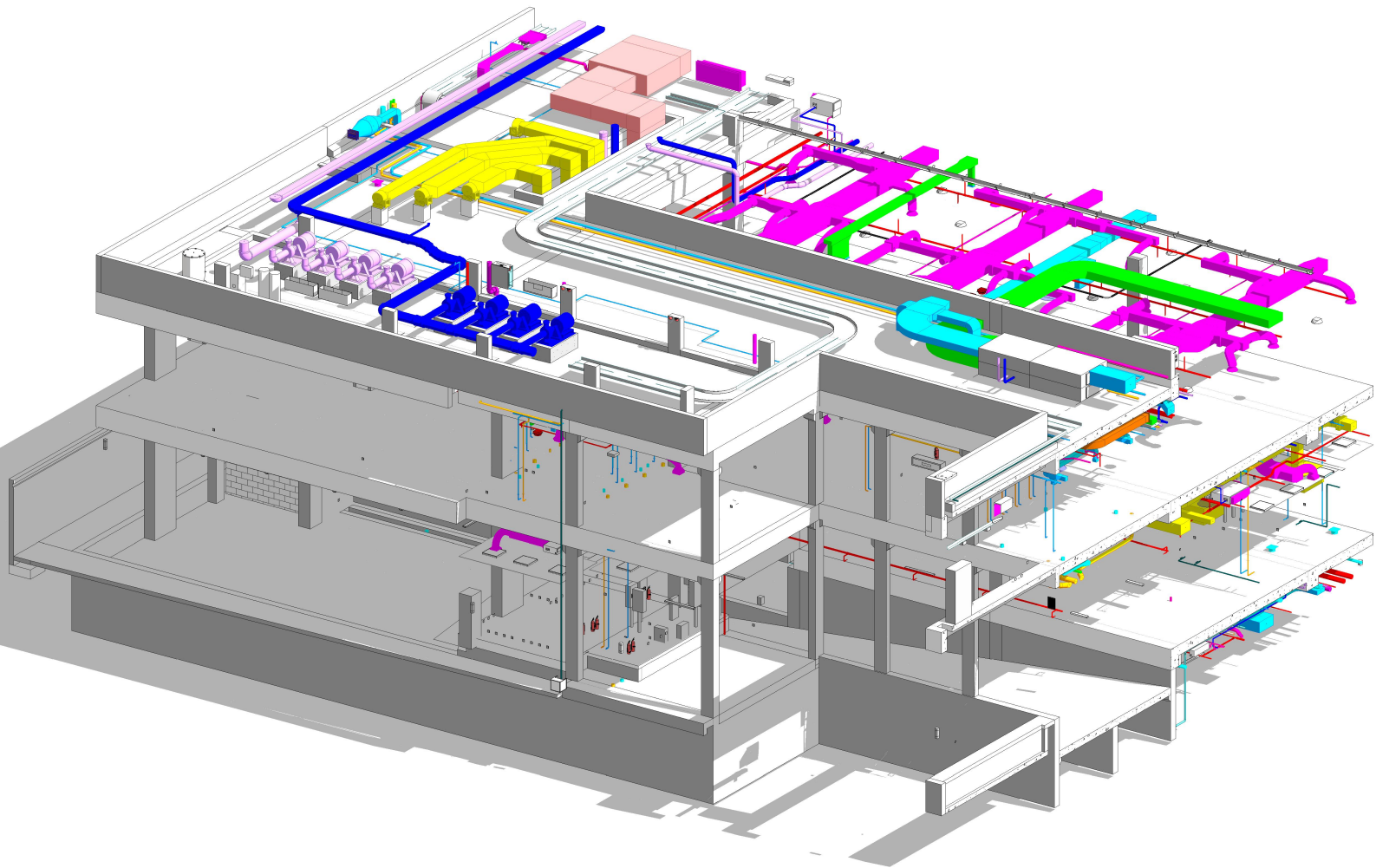

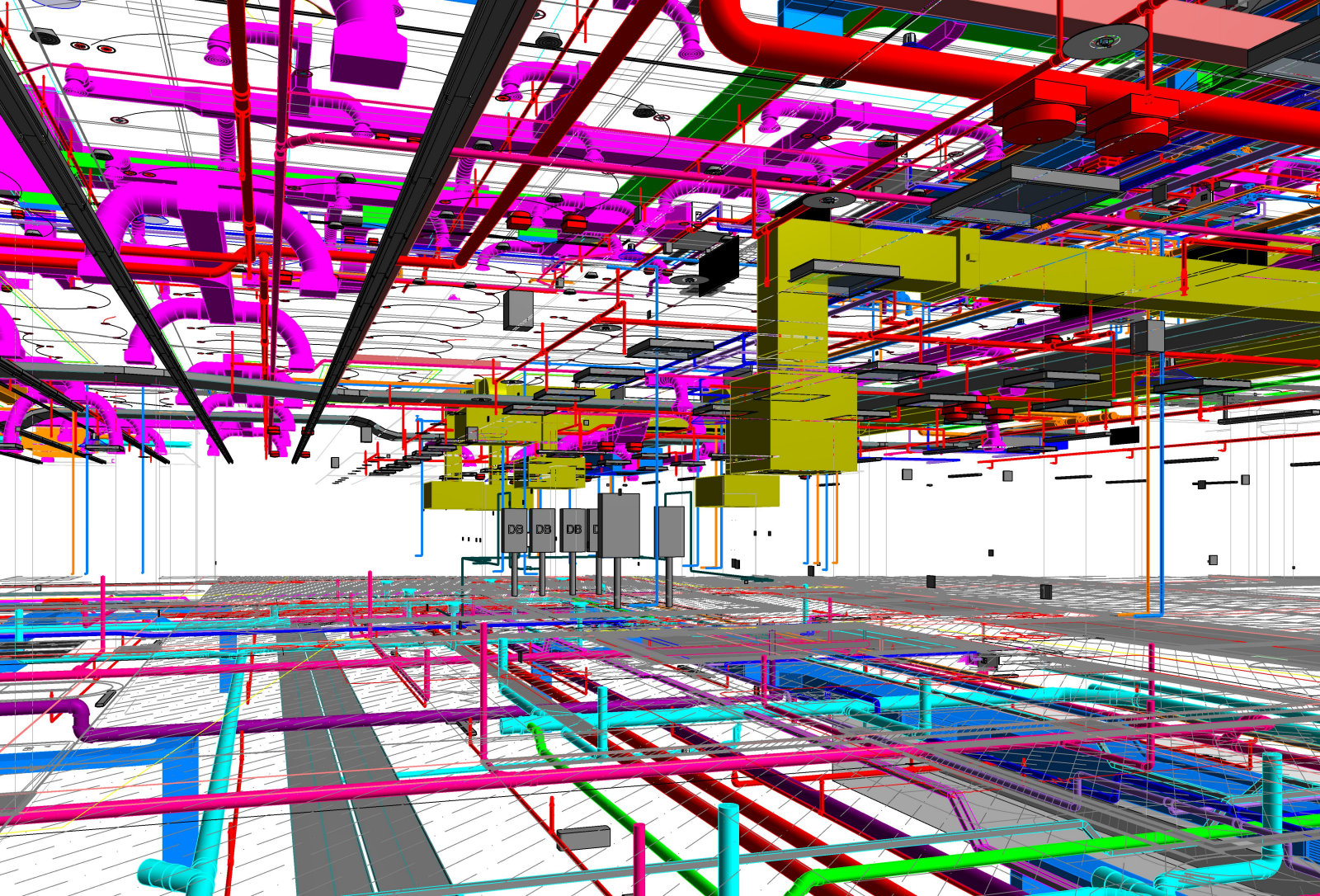



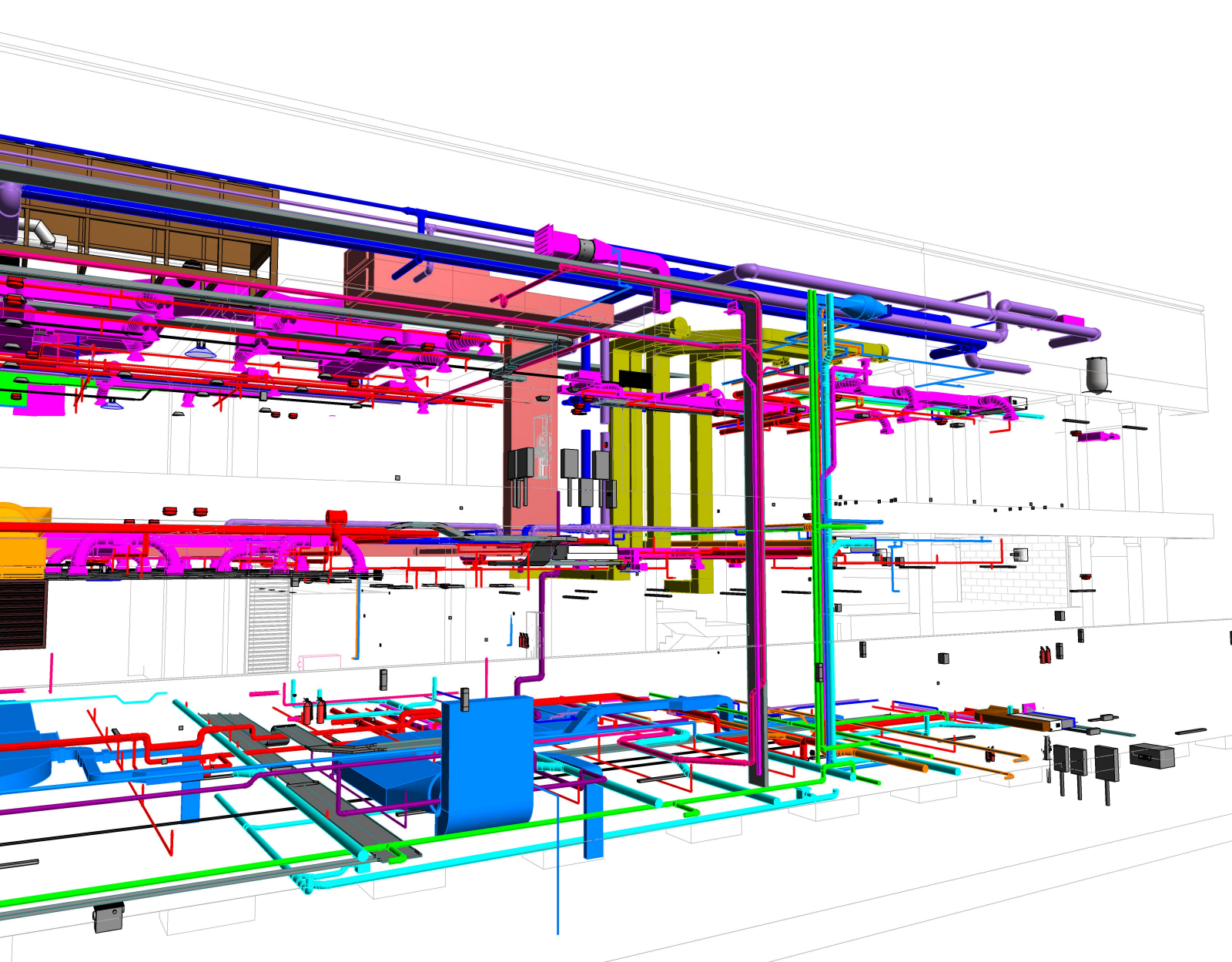

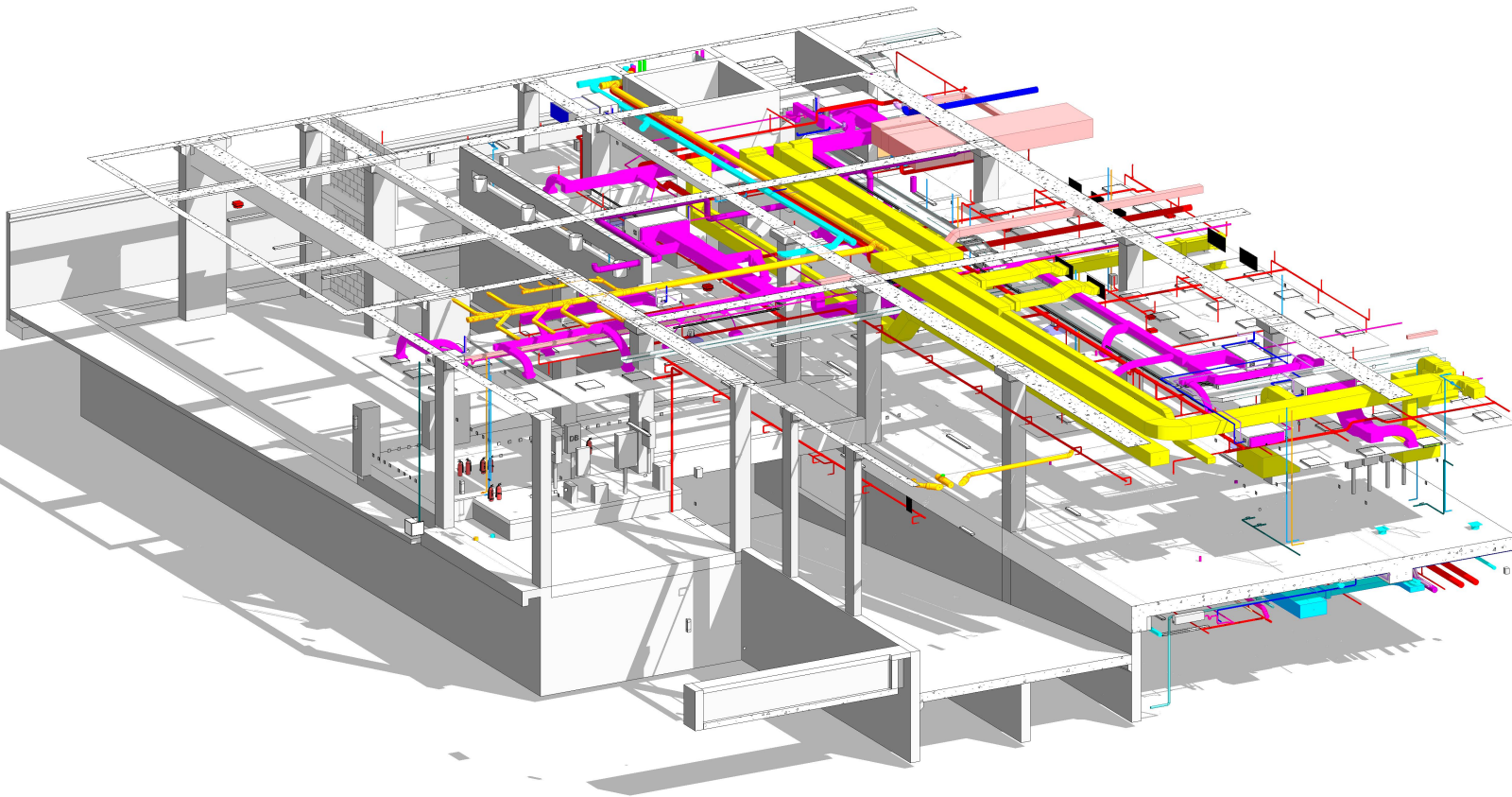





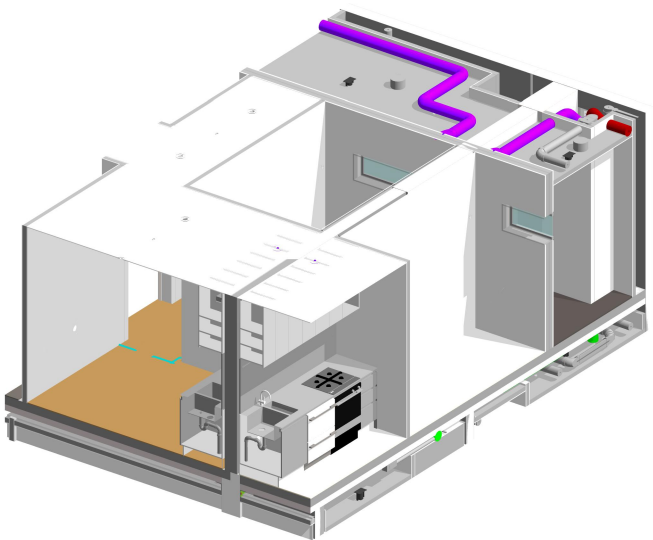

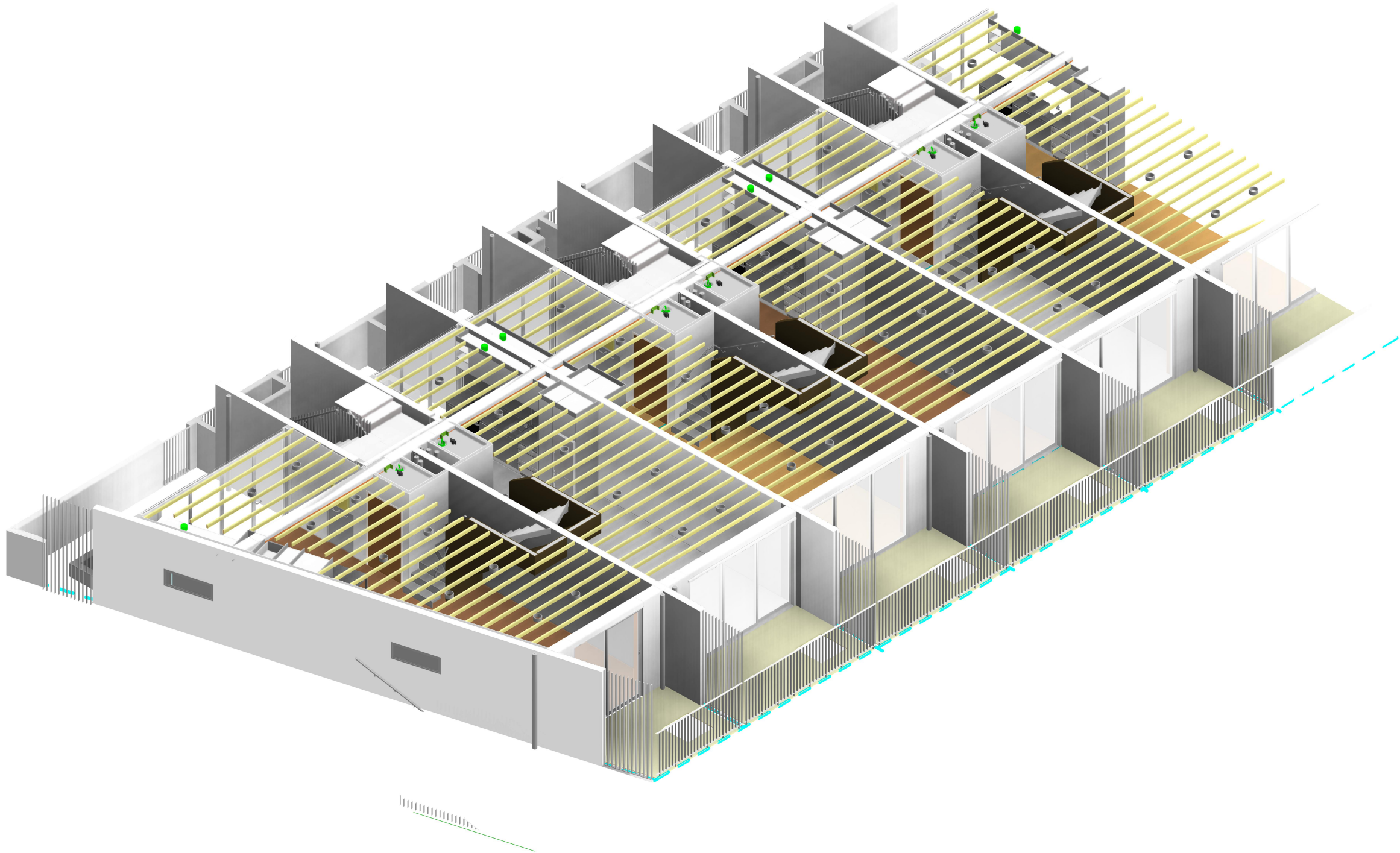

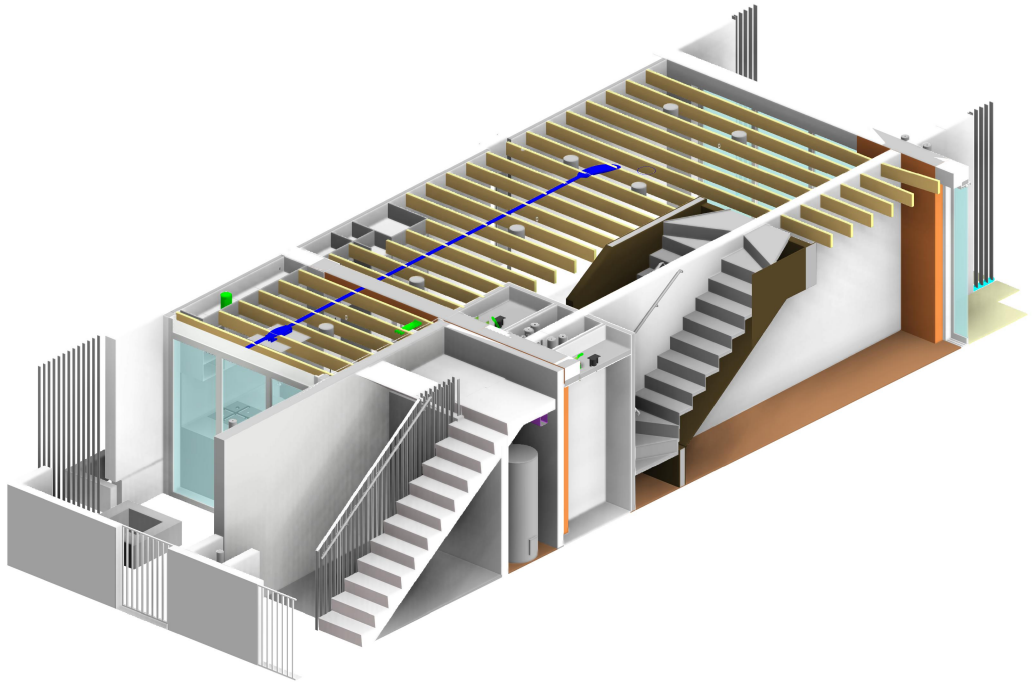

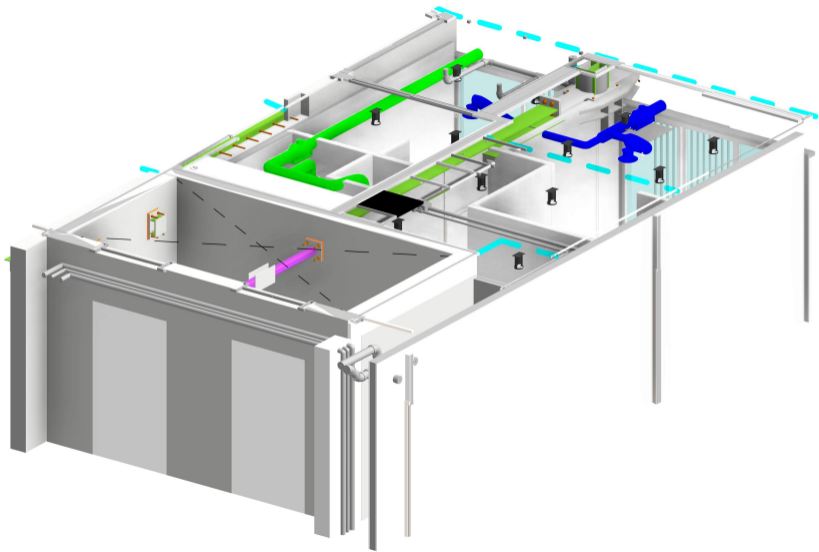



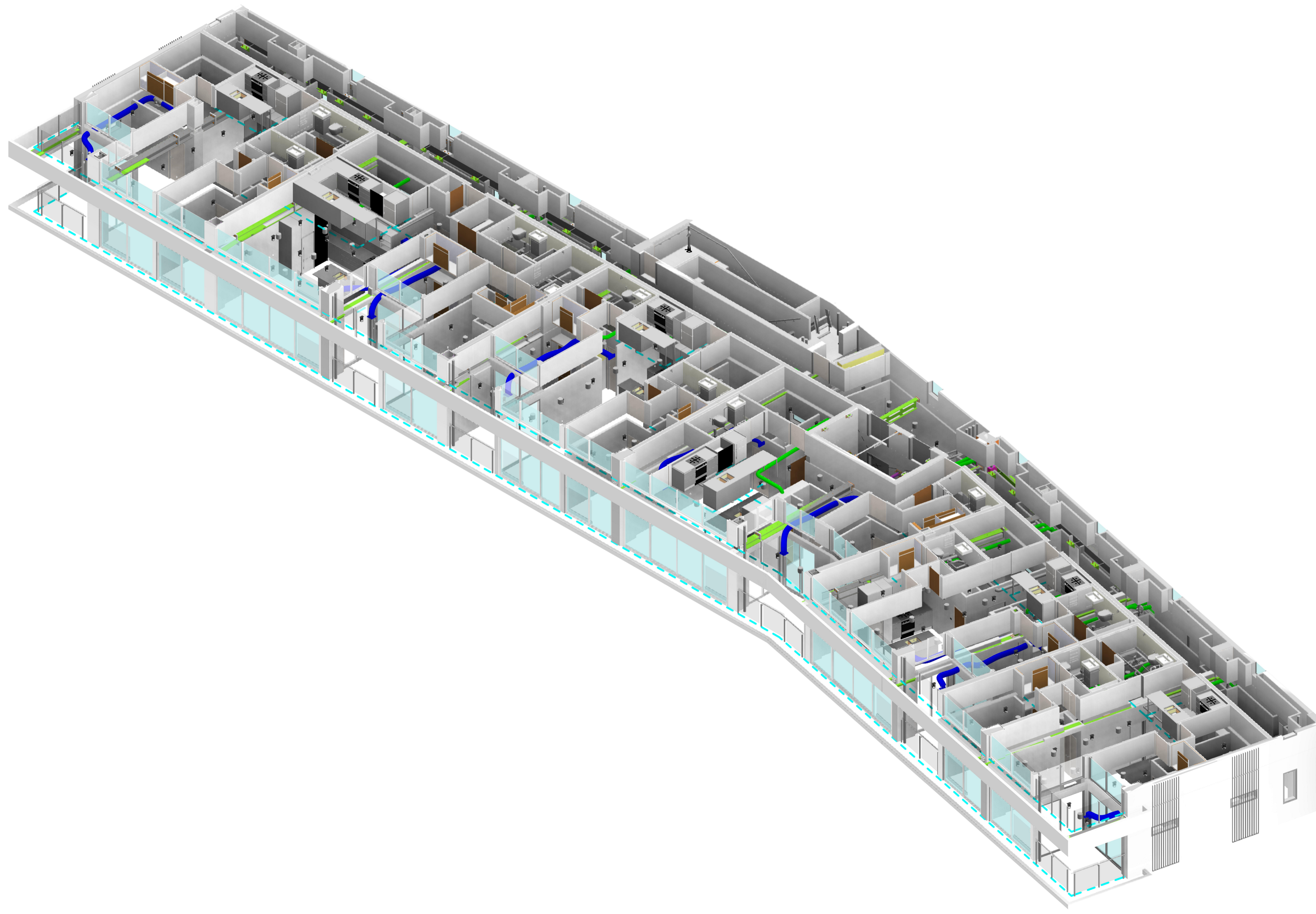



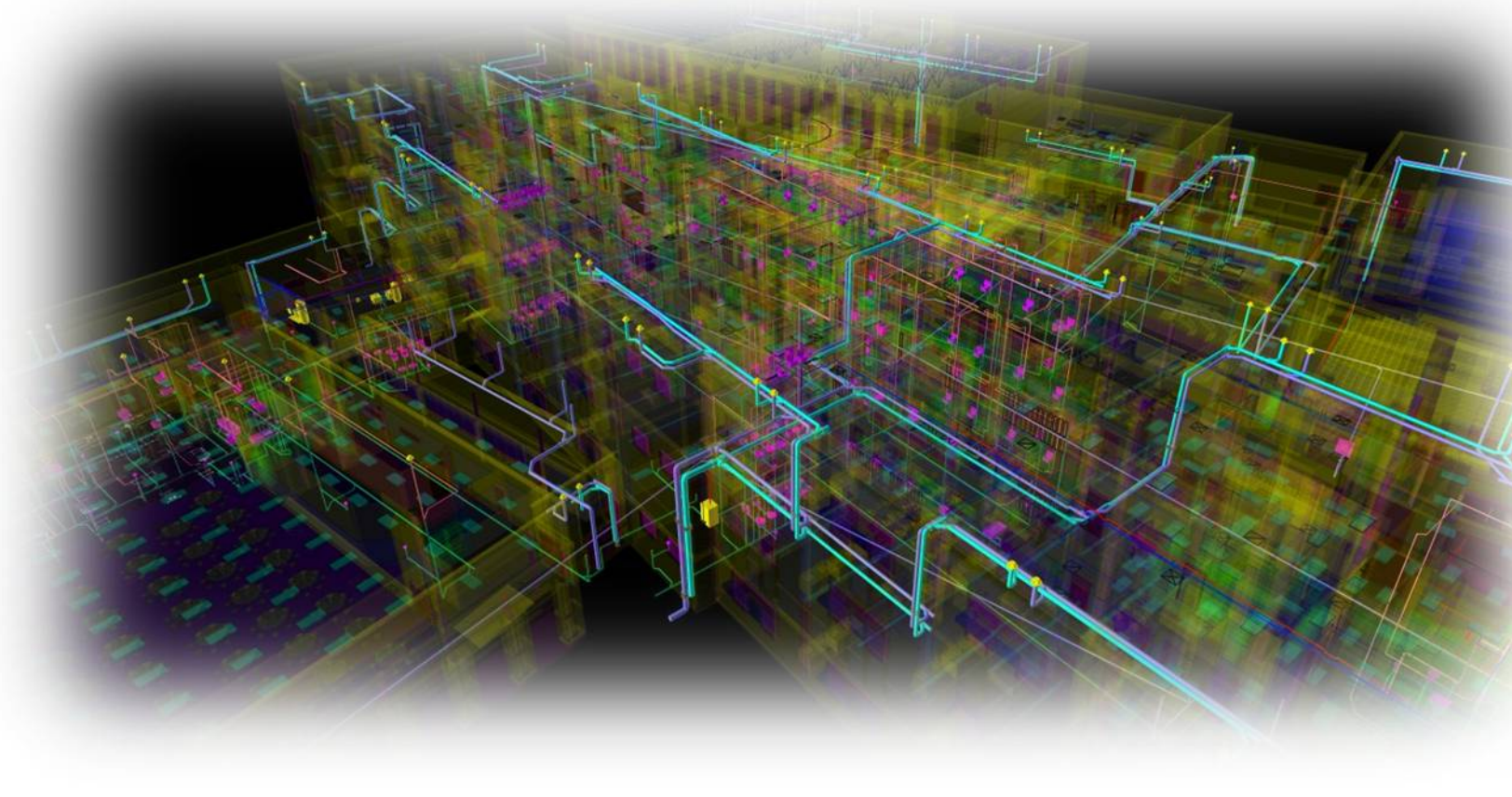

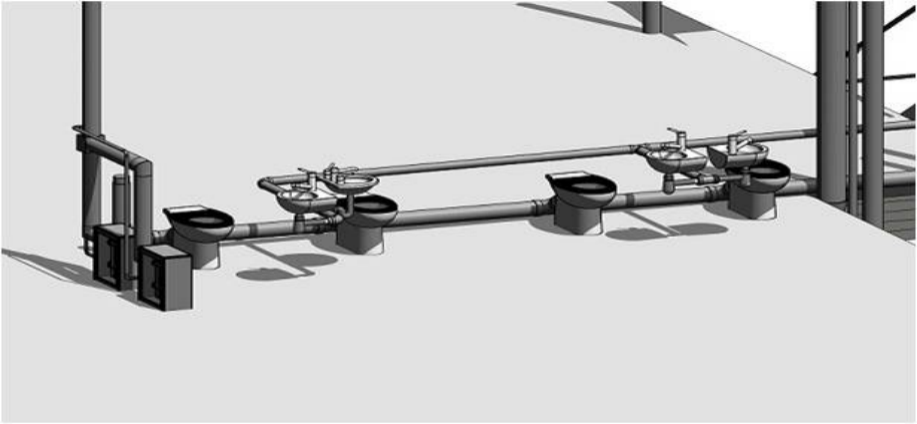

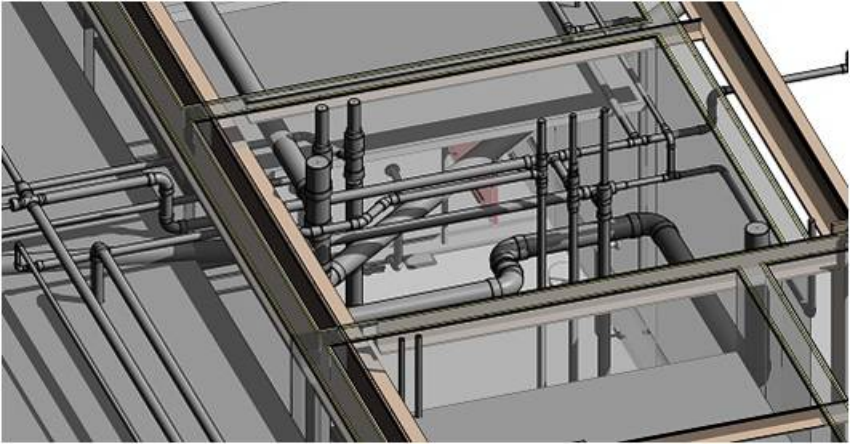

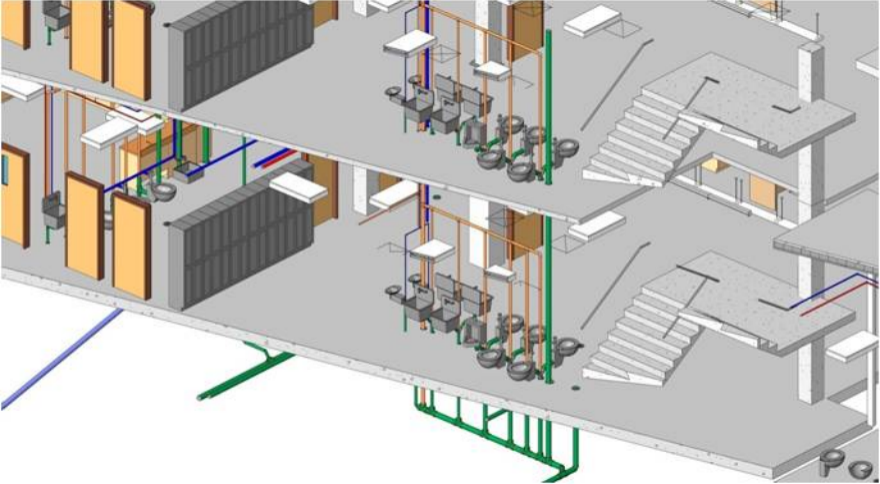

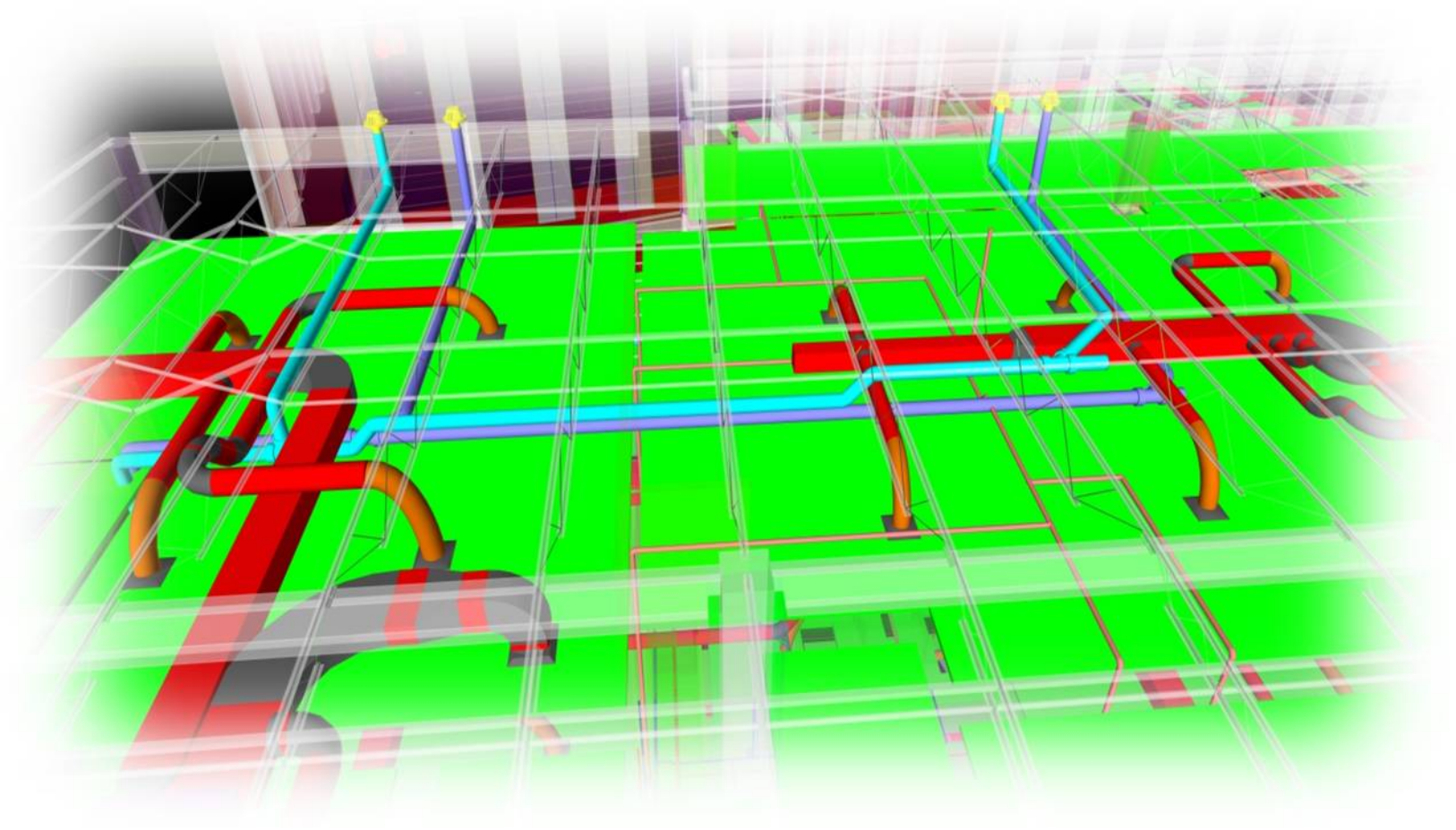

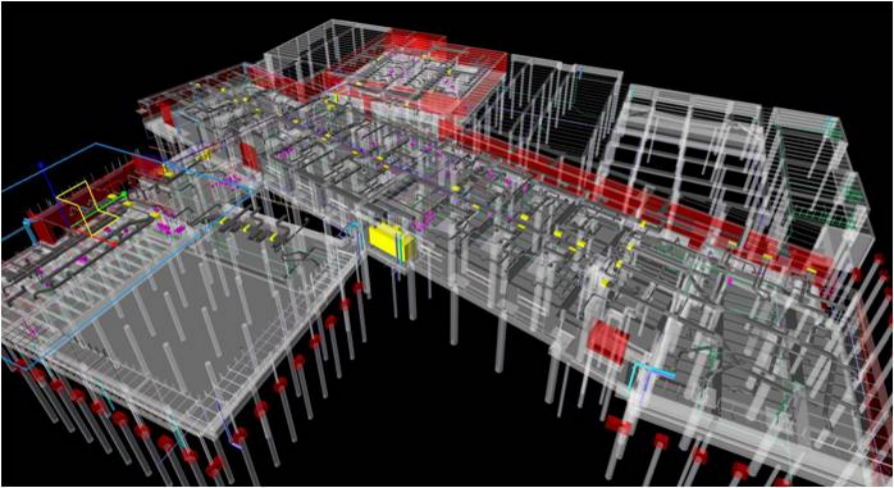



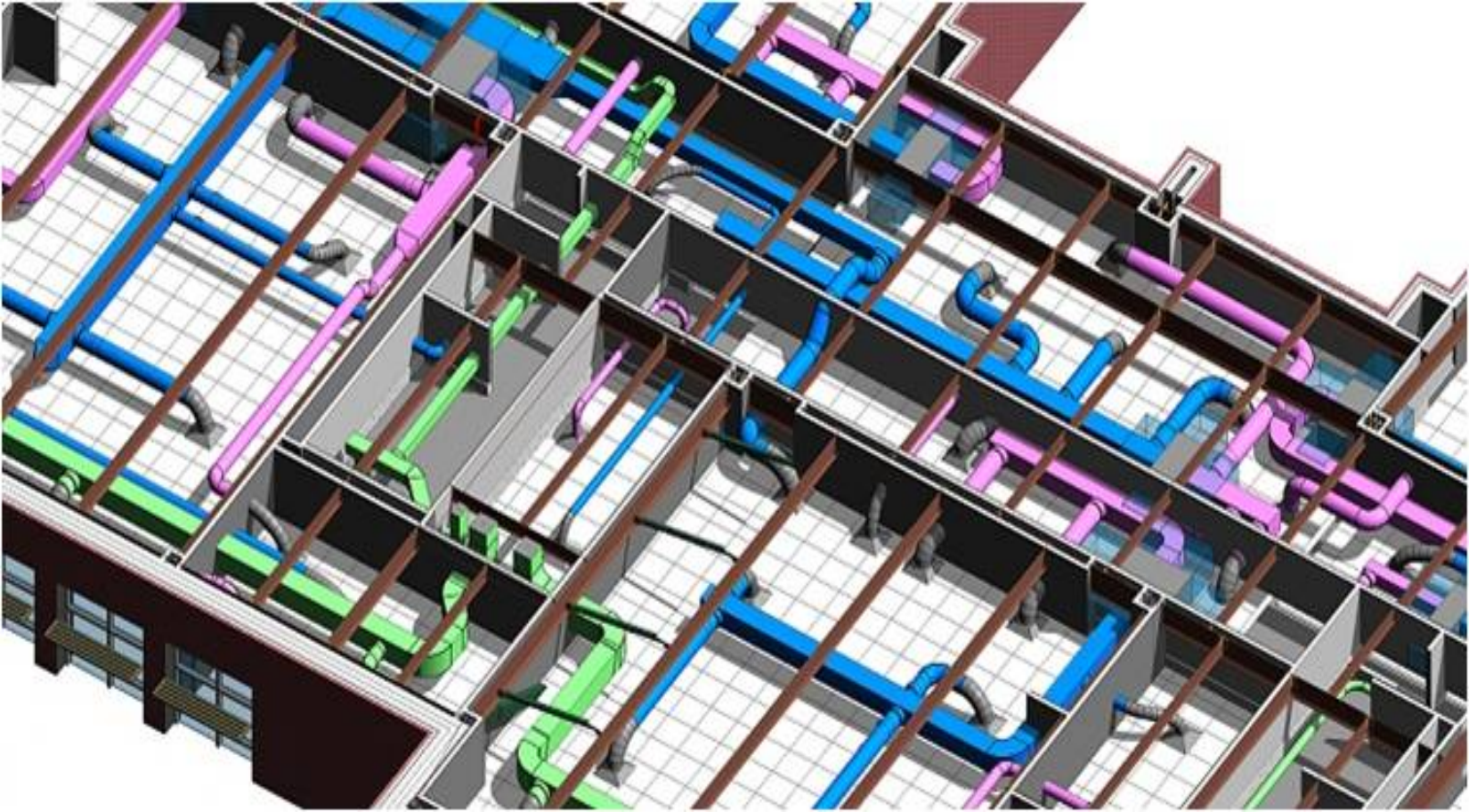

# INTEGRATED BIM SAMPLES

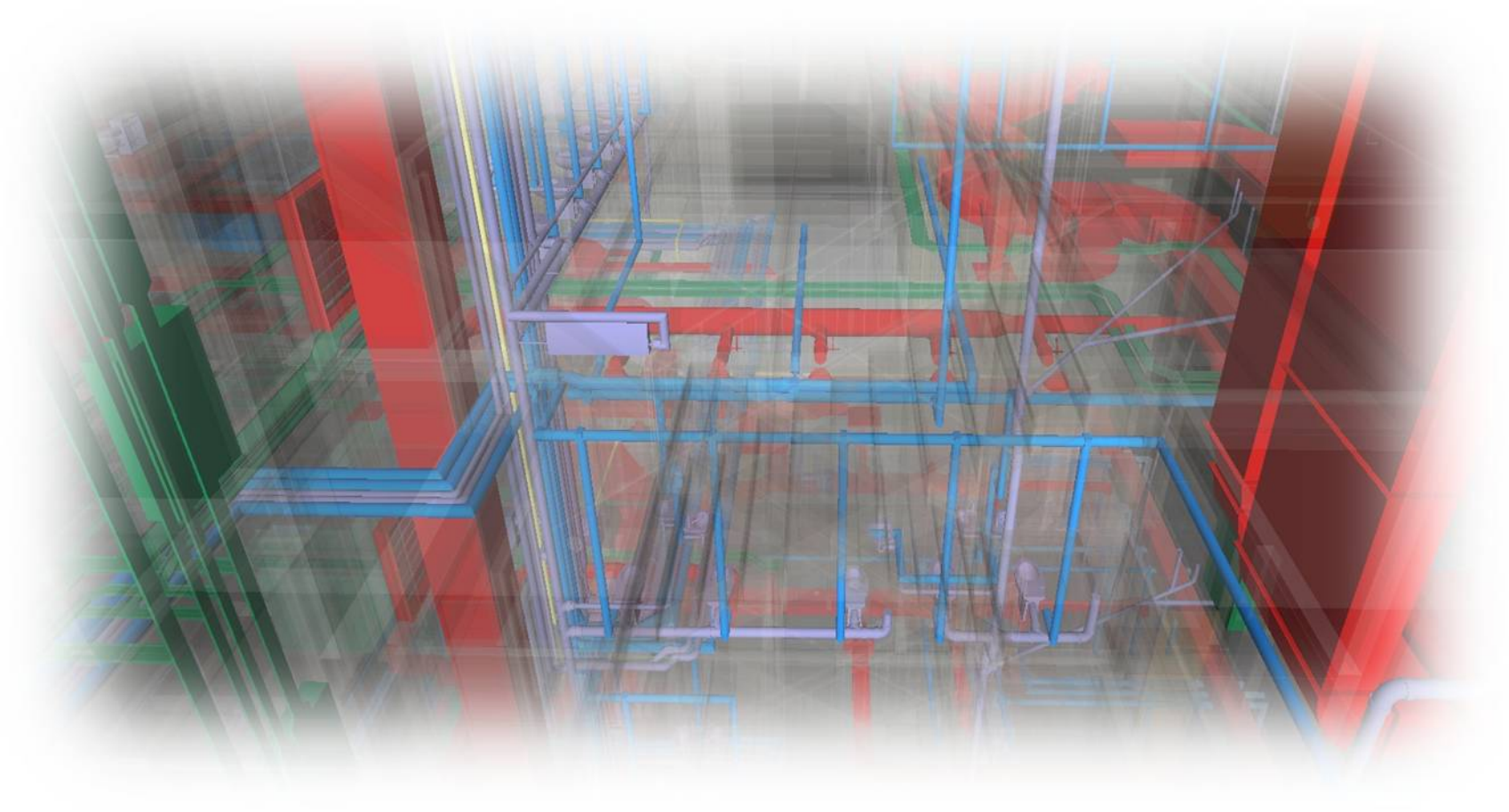

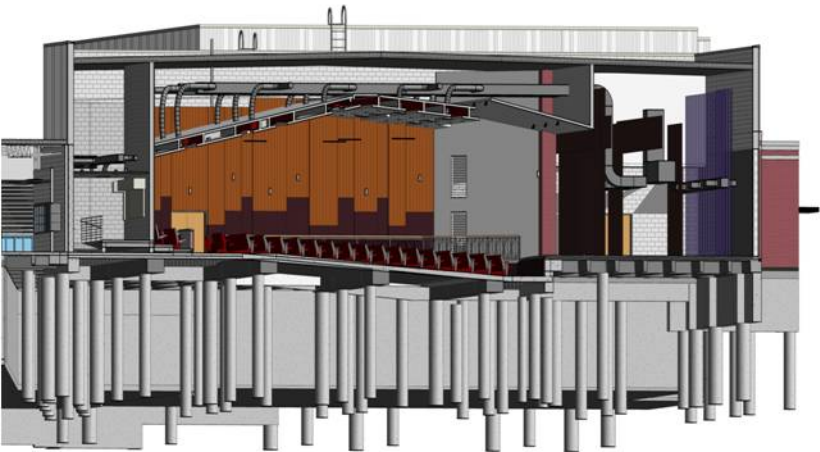



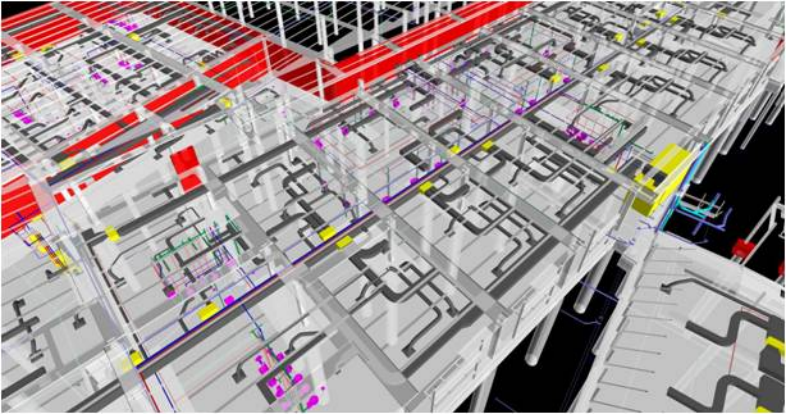

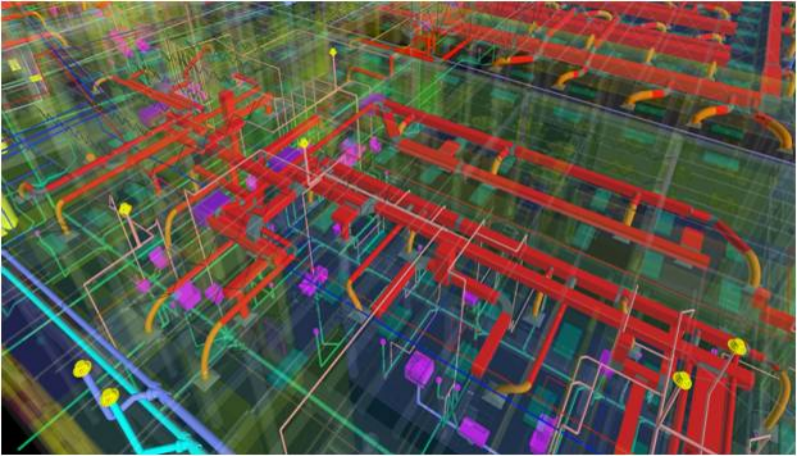

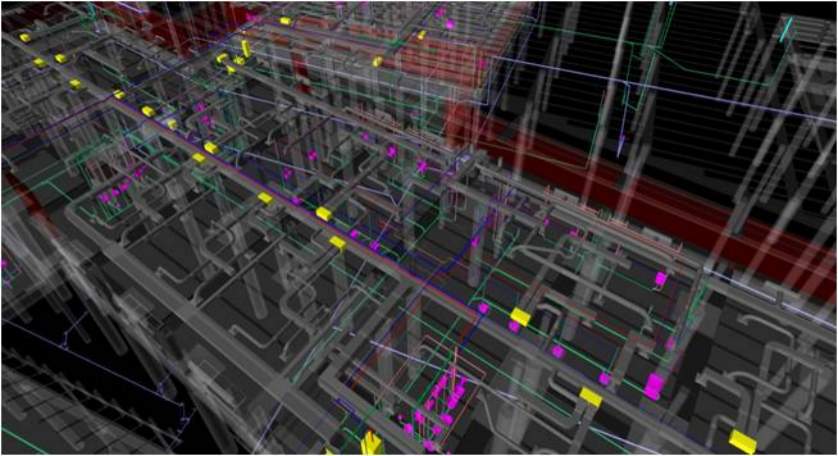



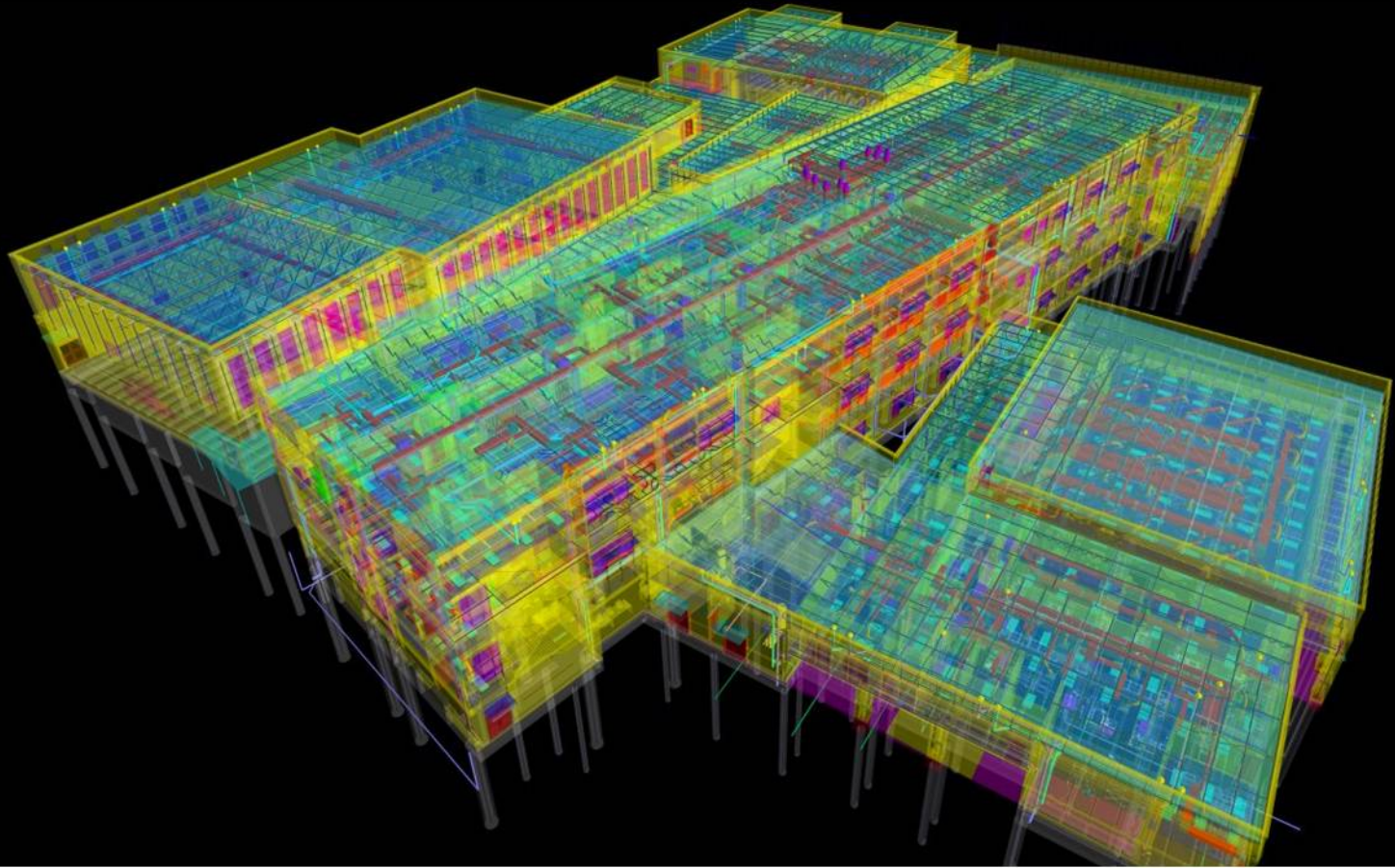

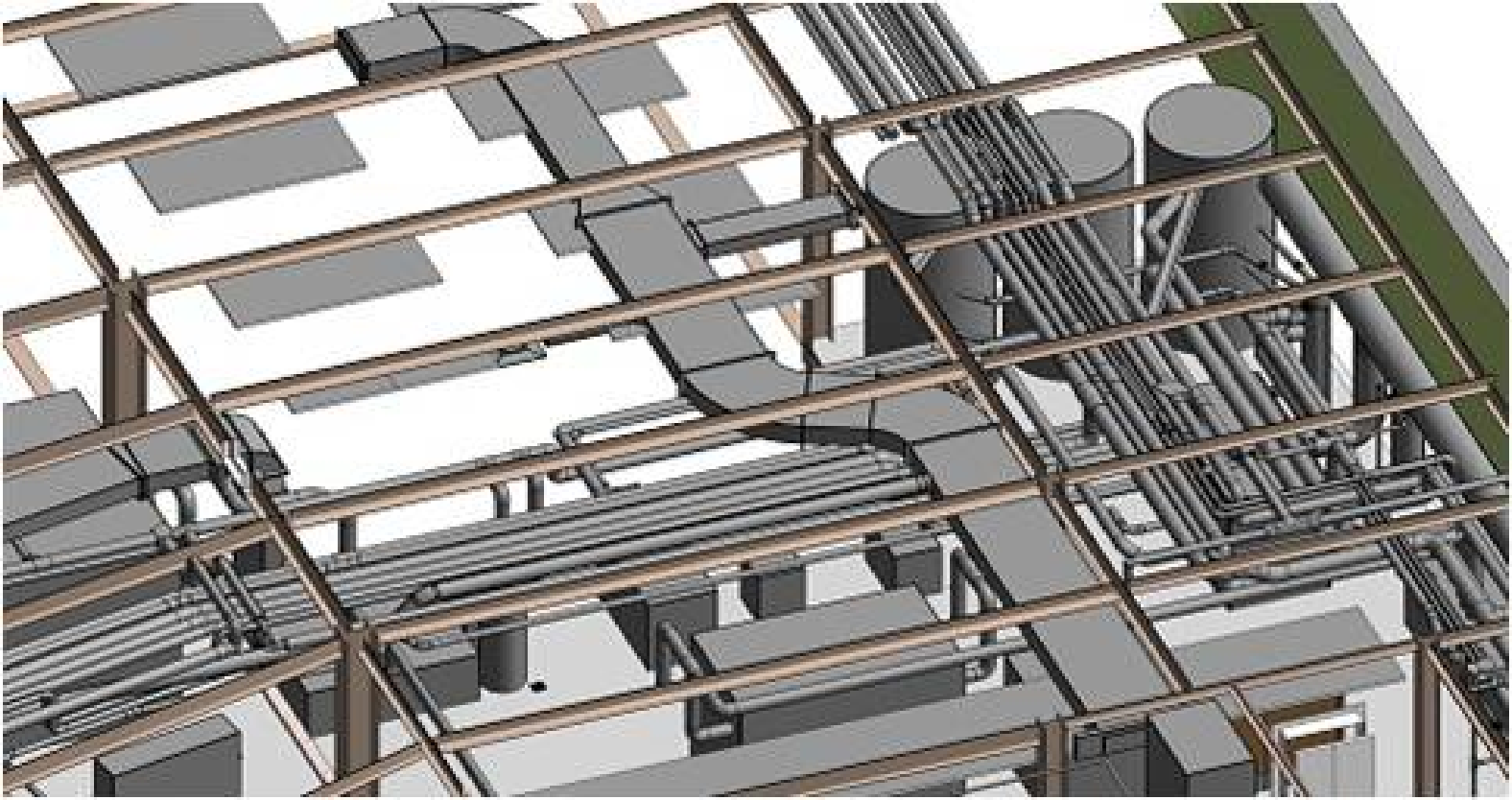

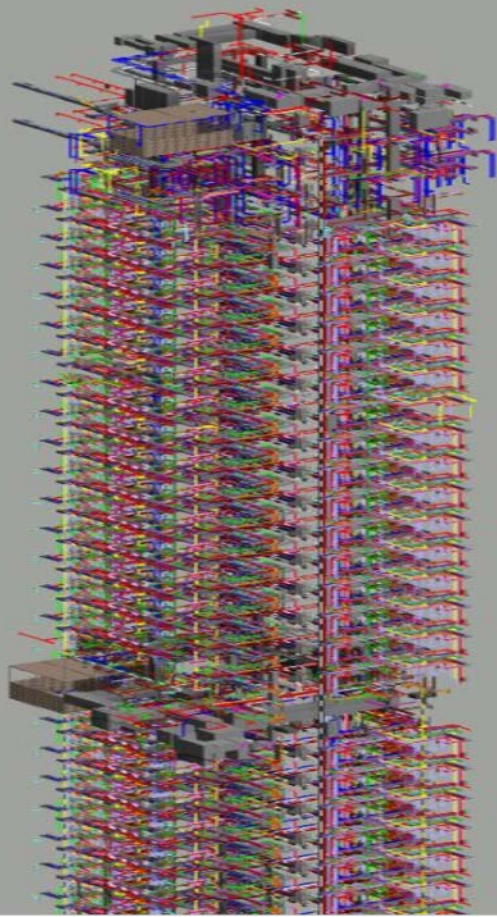

# CLASH DETECTION BIM SAMPLES

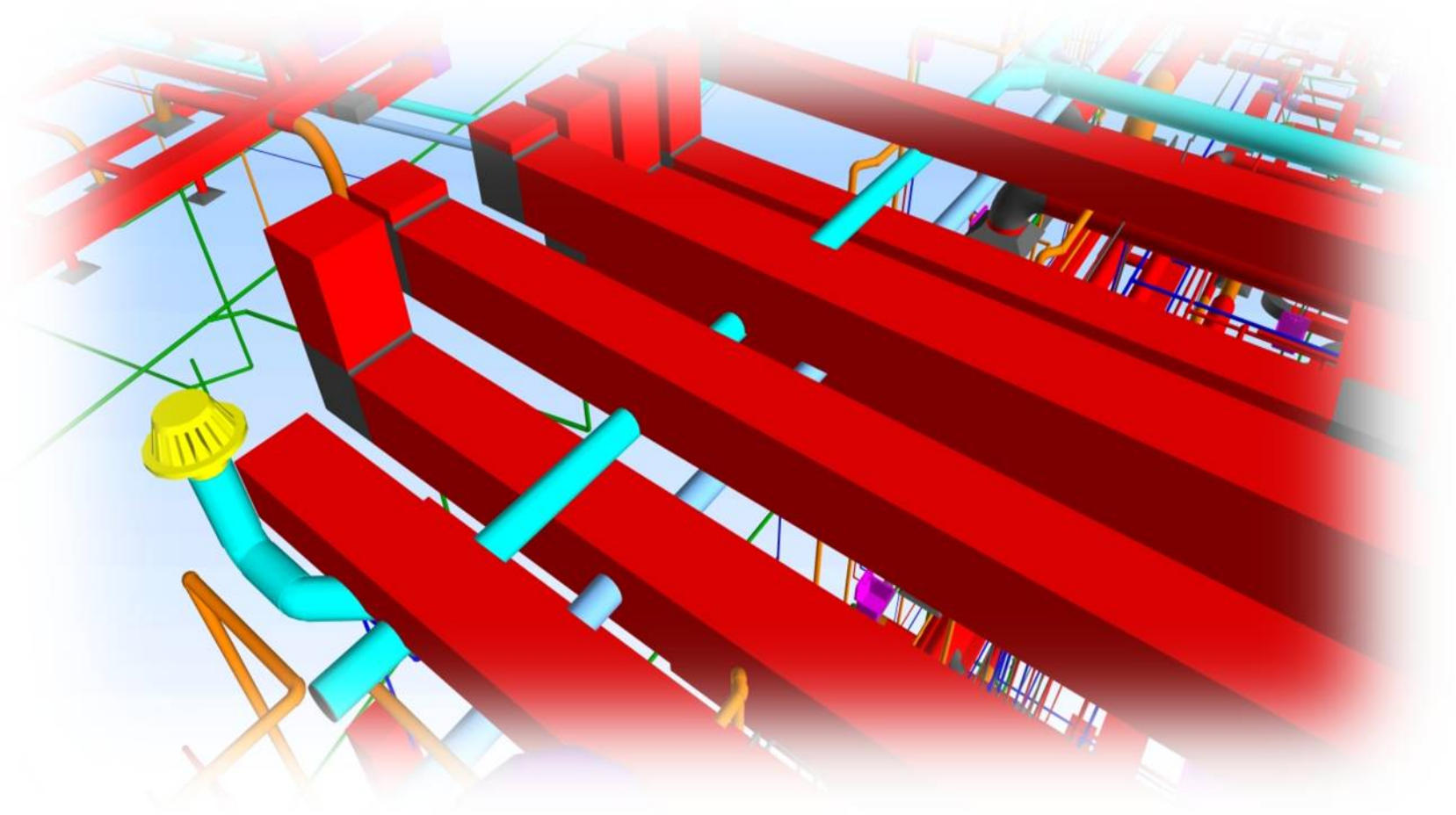

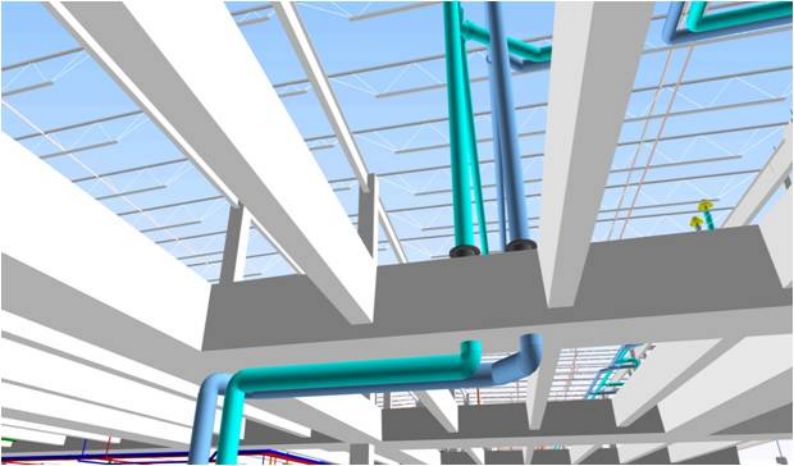

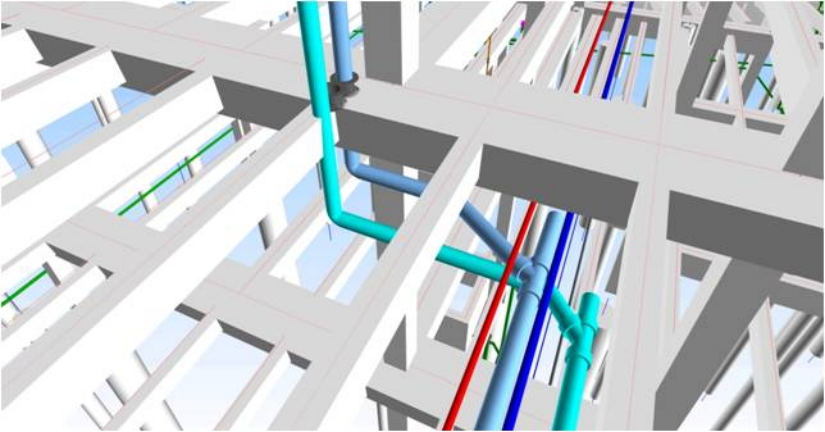

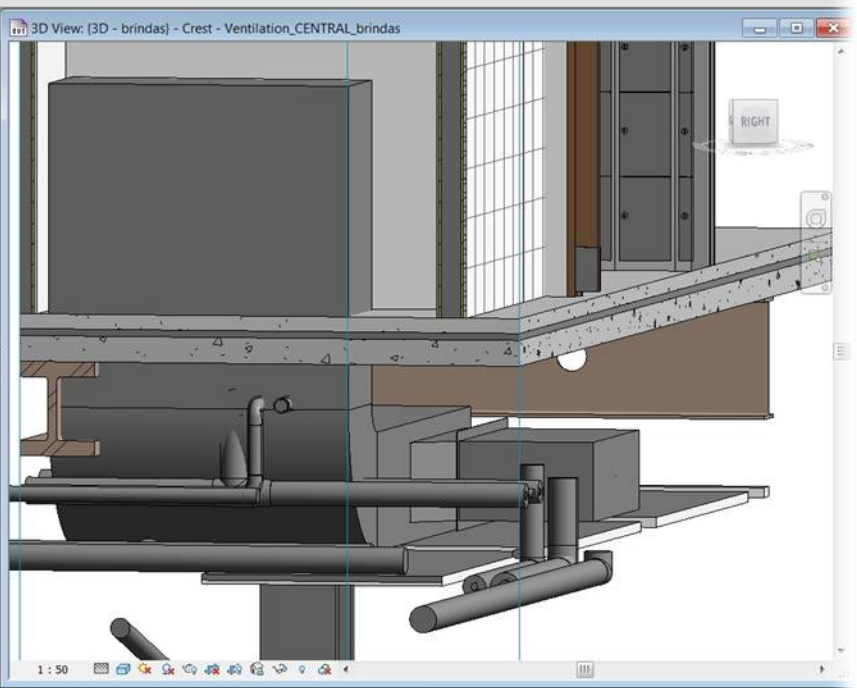
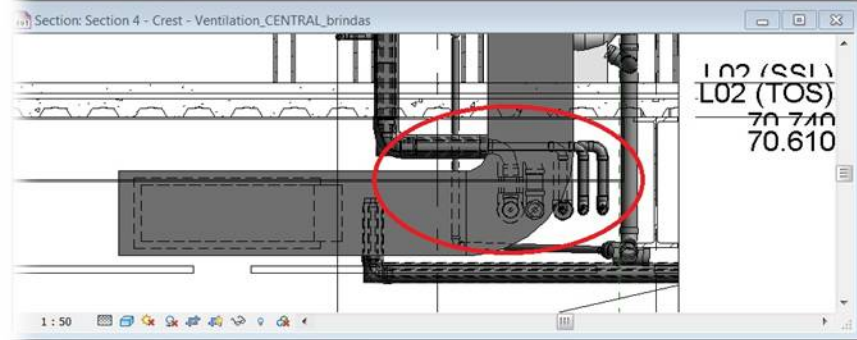
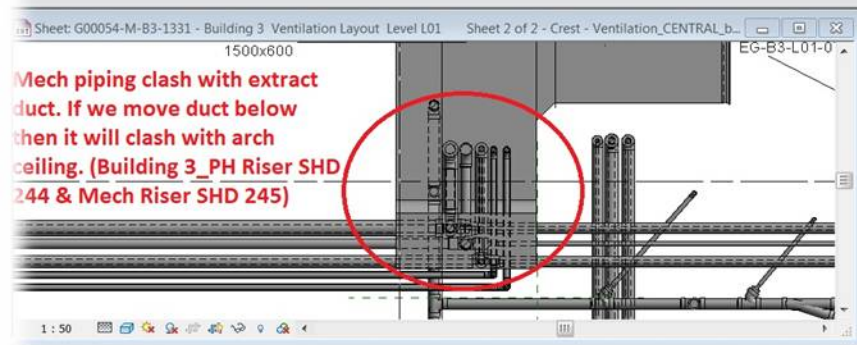
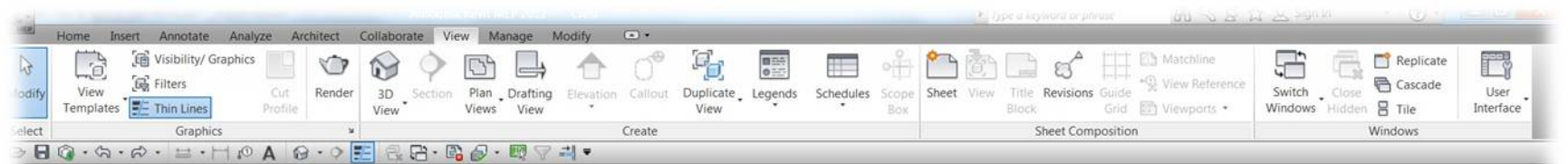



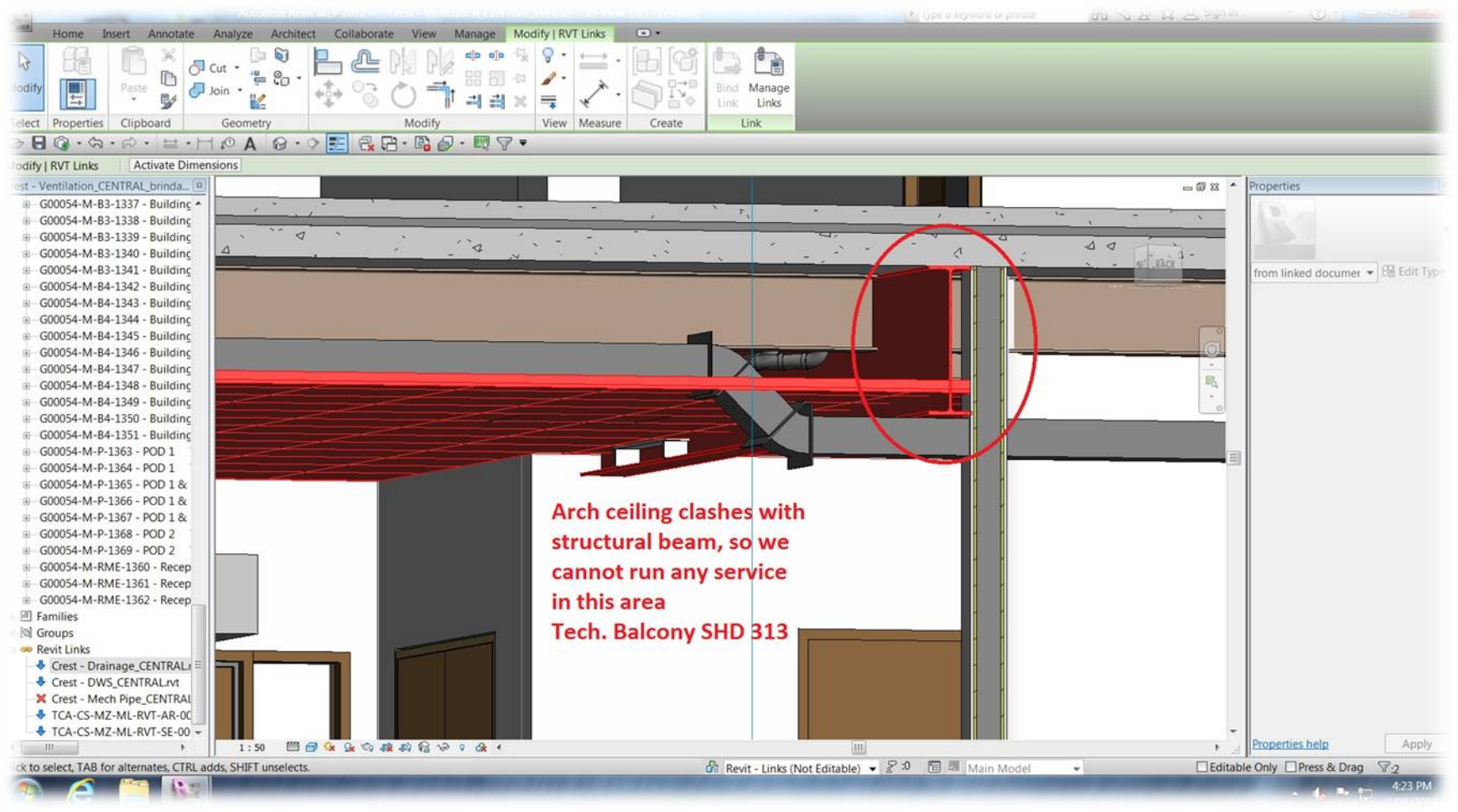

**Arch ceiling clashes with structural beam, so we cannot run any service in this area**  
**Tech. Balcony SHD 313**

- est - Ventilation\_CENTRAL\_brinda...
- G00054-M-B3-1337 - Building
- G00054-M-B3-1338 - Building
- G00054-M-B3-1339 - Building
- G00054-M-B3-1340 - Building
- G00054-M-B3-1341 - Building
- G00054-M-B4-1342 - Building
- G00054-M-B4-1343 - Building
- G00054-M-B4-1344 - Building
- G00054-M-B4-1345 - Building
- G00054-M-B4-1346 - Building
- G00054-M-B4-1347 - Building
- G00054-M-B4-1348 - Building
- G00054-M-B4-1349 - Building
- G00054-M-B4-1350 - Building
- G00054-M-B4-1351 - Building
- G00054-M-P-1363 - POD 1
- G00054-M-P-1364 - POD 1
- G00054-M-P-1365 - POD 1 &
- G00054-M-P-1366 - POD 1 &
- G00054-M-P-1367 - POD 1 &
- G00054-M-P-1368 - POD 2
- G00054-M-P-1369 - POD 2
- G00054-M-RME-1360 - Recep
- G00054-M-RME-1361 - Recep
- G00054-M-RME-1362 - Recep
- Families
- Groups
- Revit Links
  - Crest - Drainage\_CENTRAL
  - Crest - DWS\_CENTRALrvt
  - Crest - Mech Pipe\_CENTRAL
  - TCA-CS-MZ-ML-RVT-AR-0C
  - TCA-CS-MZ-ML-RVT-SE-00

Properties

from linked document Edit Type

Properties help Apply

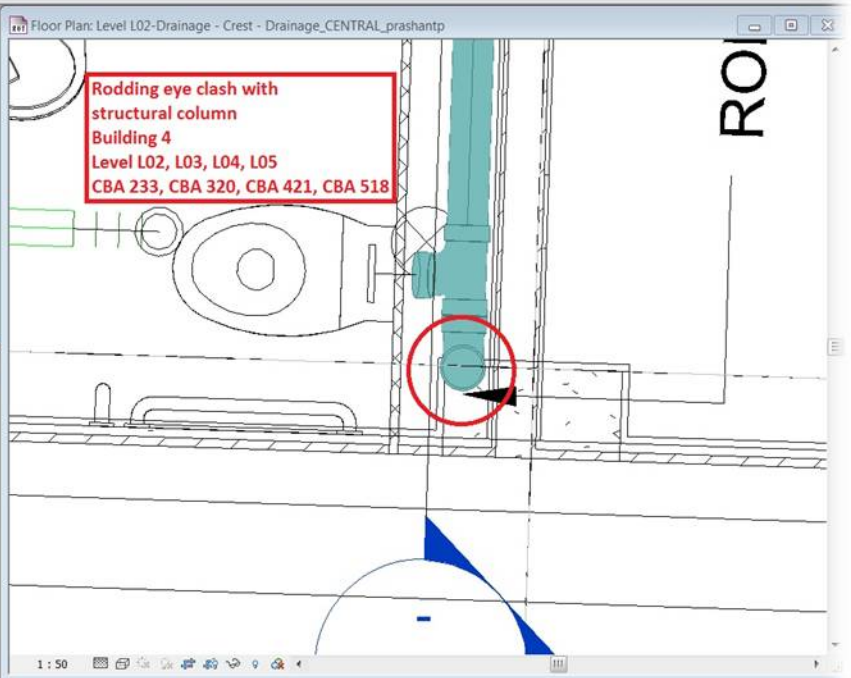
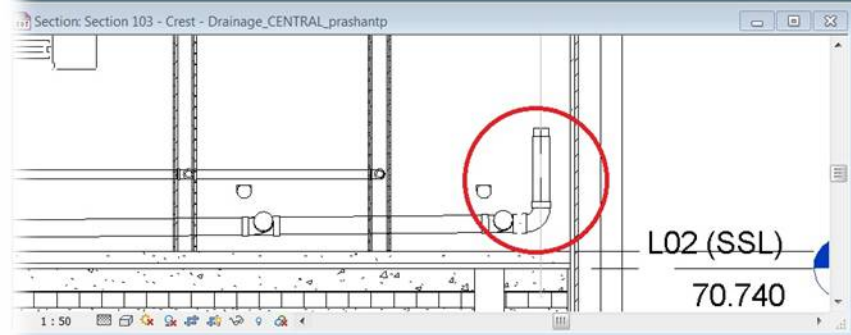
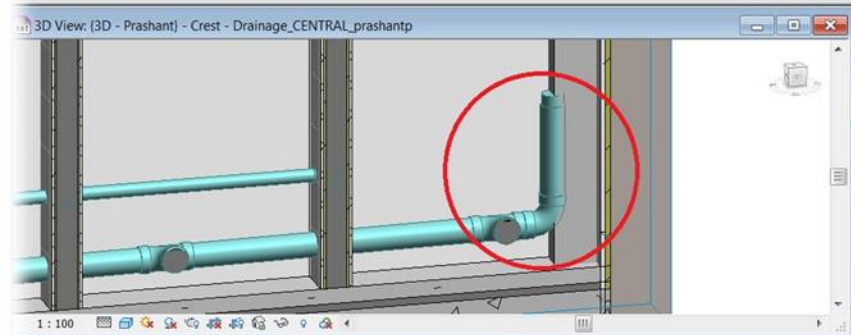

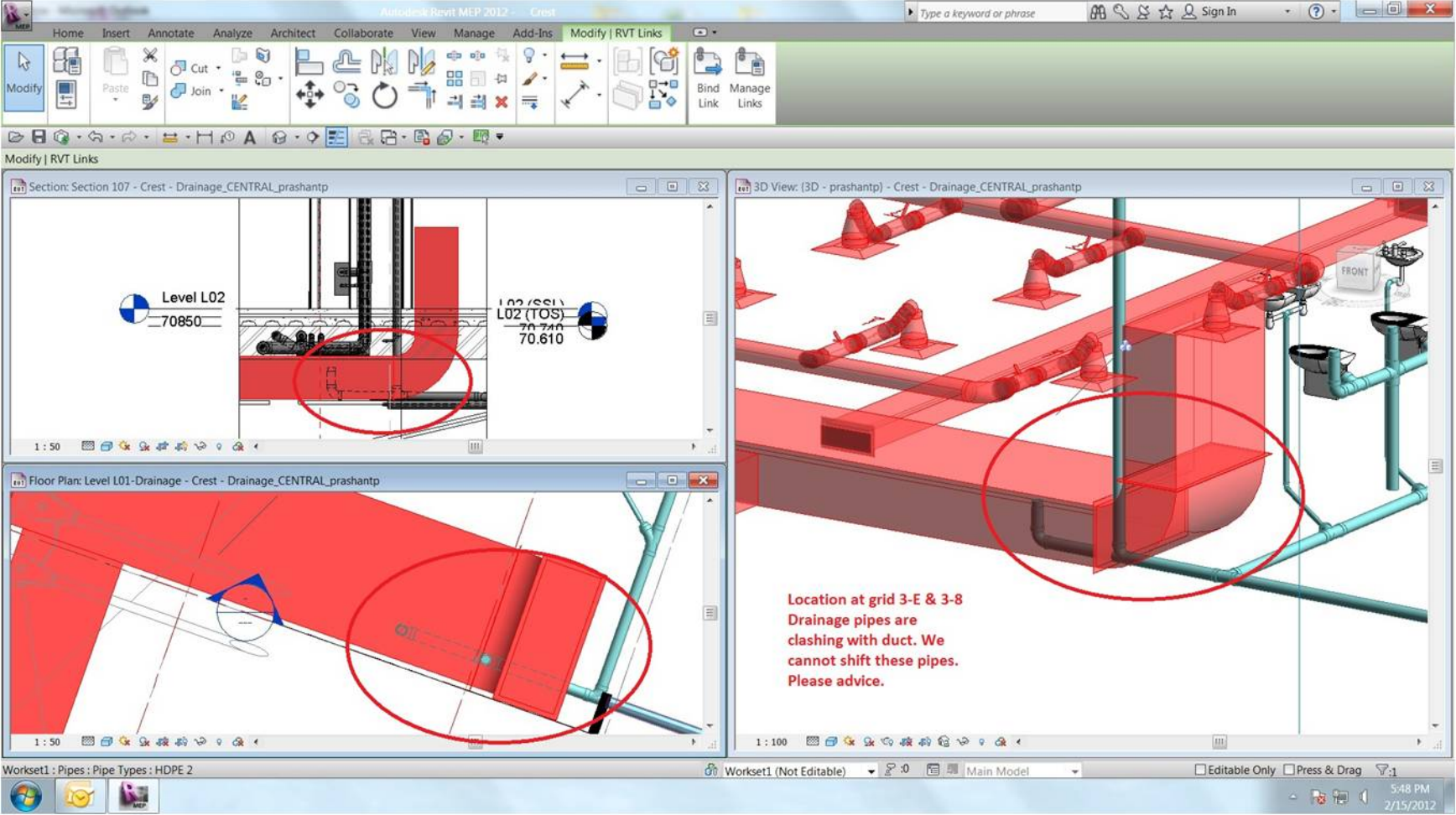



Modify | Pipes Diameter: 40

Section: Section 3 - Crest - Drainage\_CENTRAL\_brindas



1 : 50

Floor Plan: Level L03-Drainage - Crest - Drainage\_CENTRAL\_brindas

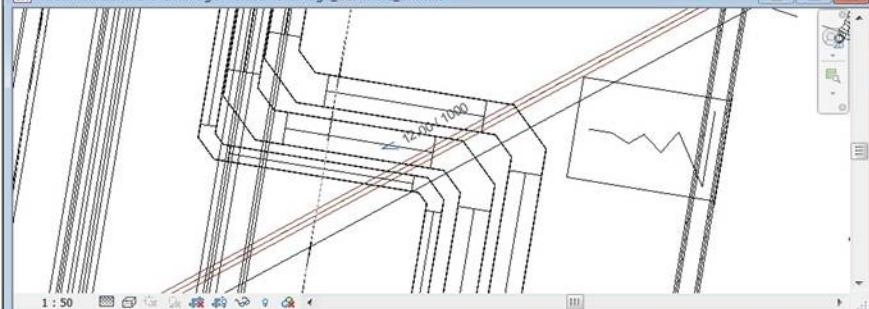

1 : 50

3D View: (3D - brindas) - Crest - Drainage\_CENTRAL\_brindas

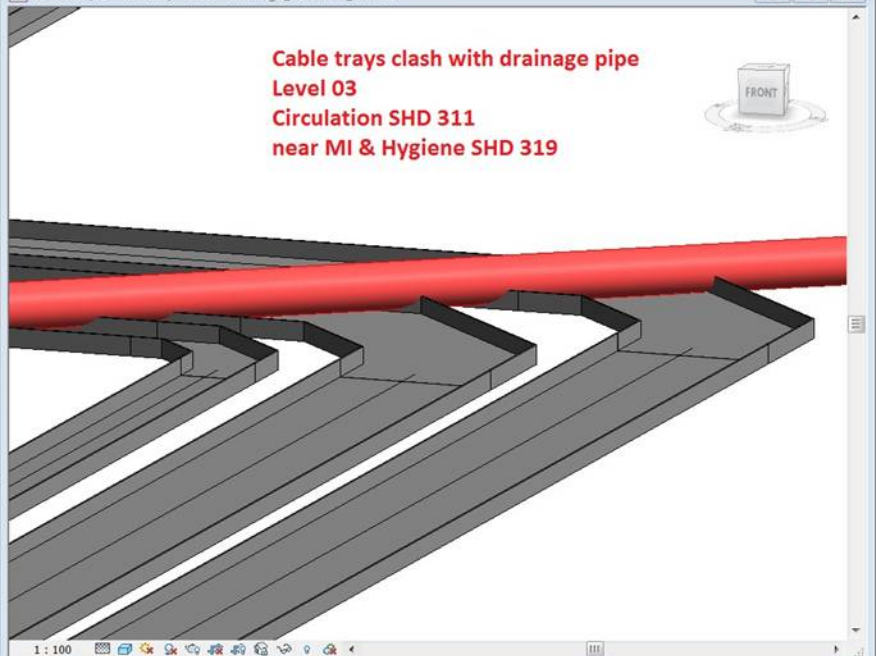

1 : 100

**THANK YOU**