

**MEPF BIM
MODELING SAMPLES**

BASEMENT HIGH LEVEL CO-ORDINATED VIEW

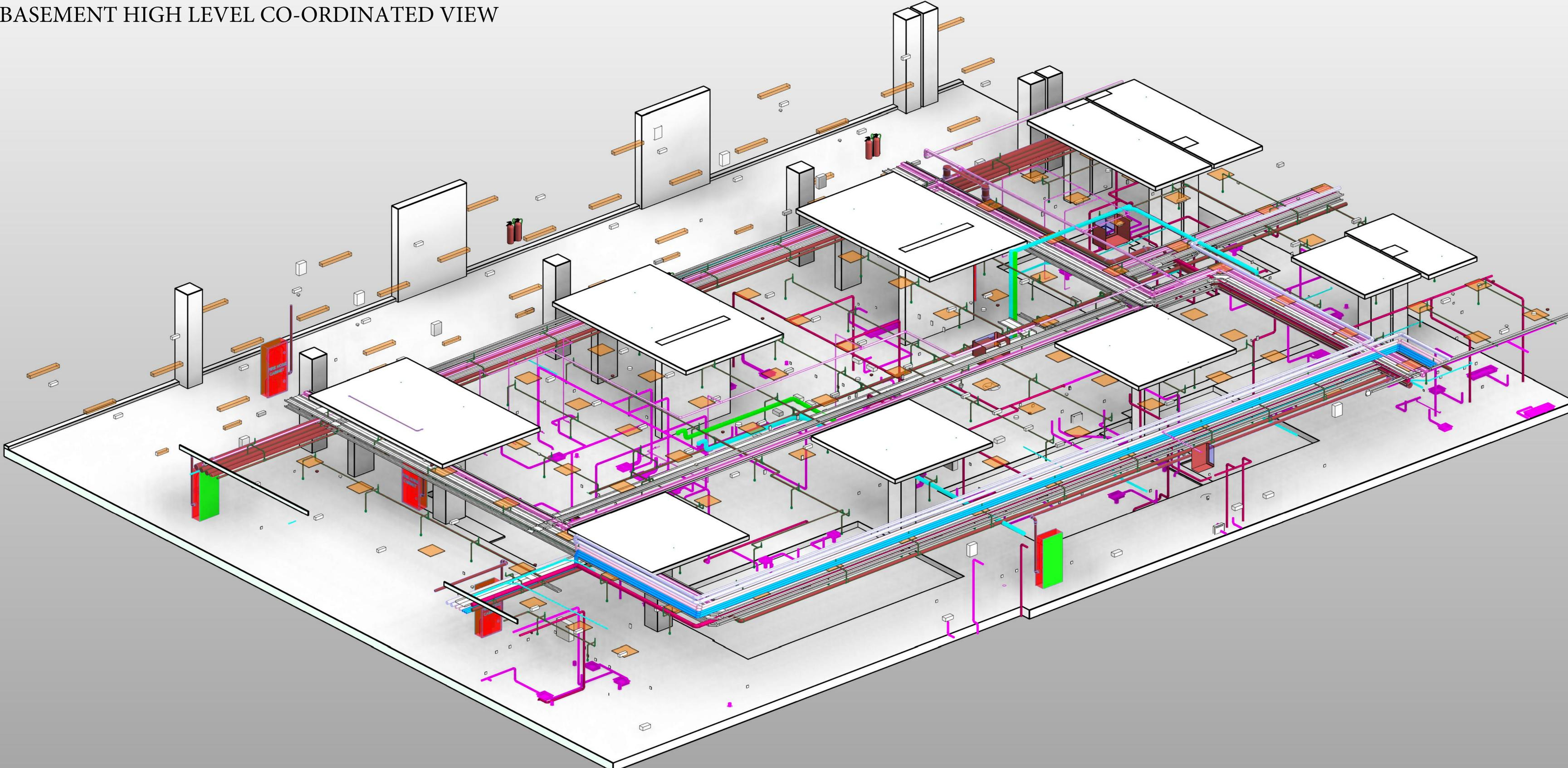

BASEMENT LOW LEVEL CO-ORDINATED VIEW

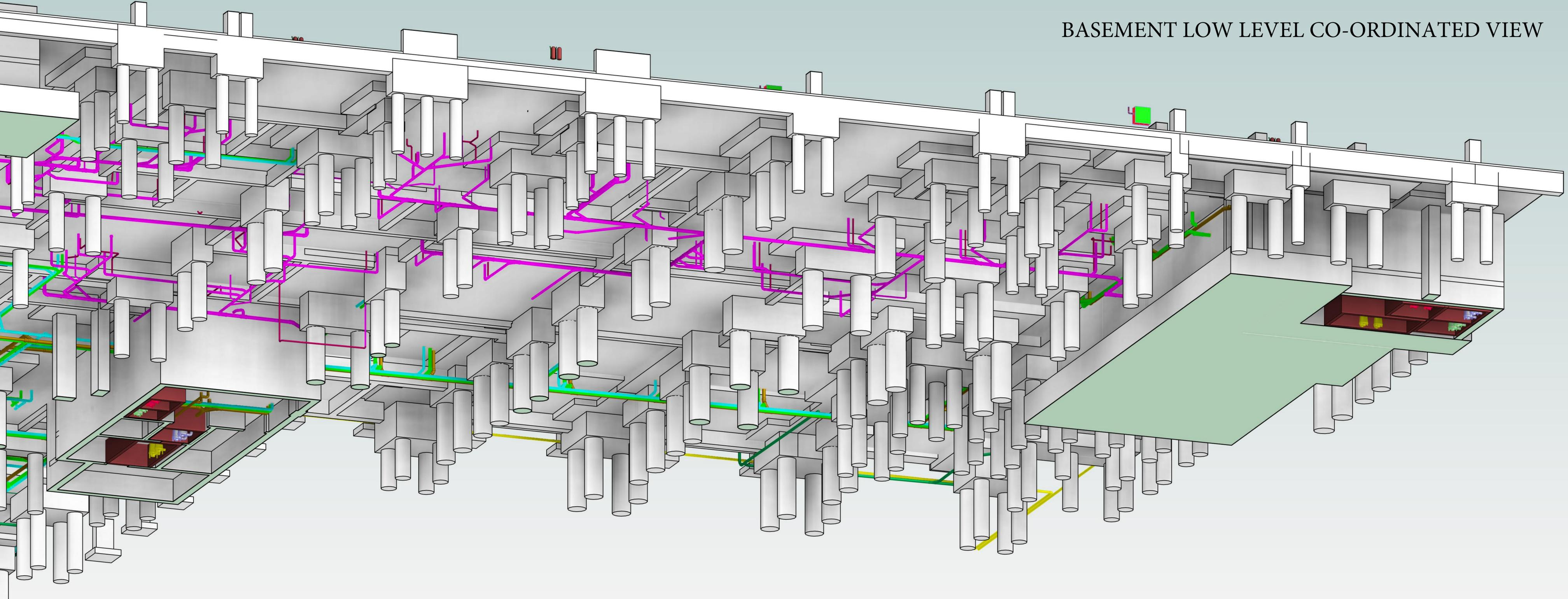

CHILLED WATER PUMP ROOM, KITCHEN EXHAUST AT ROOF

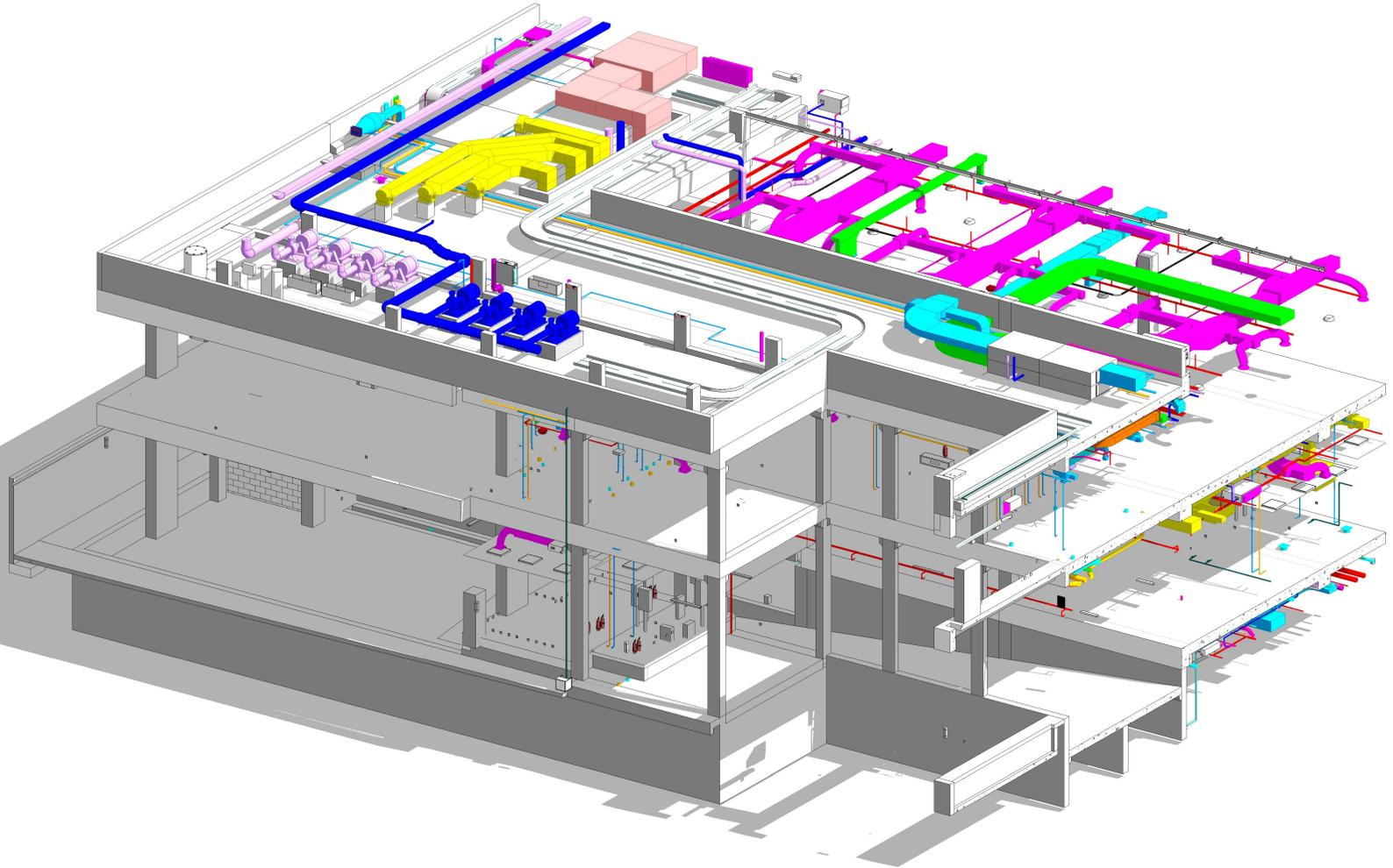

CHILLER ISOMETRIC VIEW

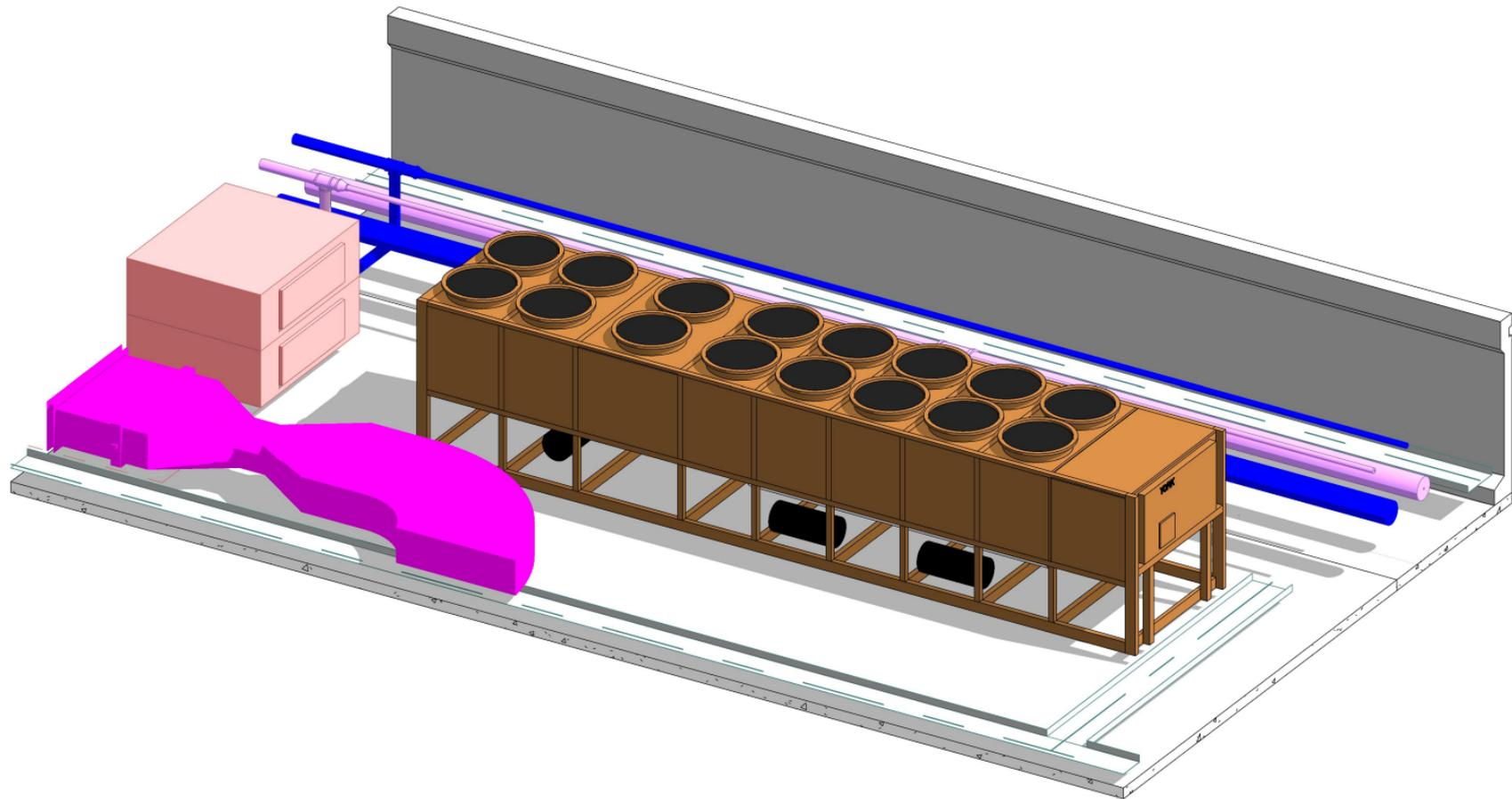

CO-ORDINATED MEP VIEW

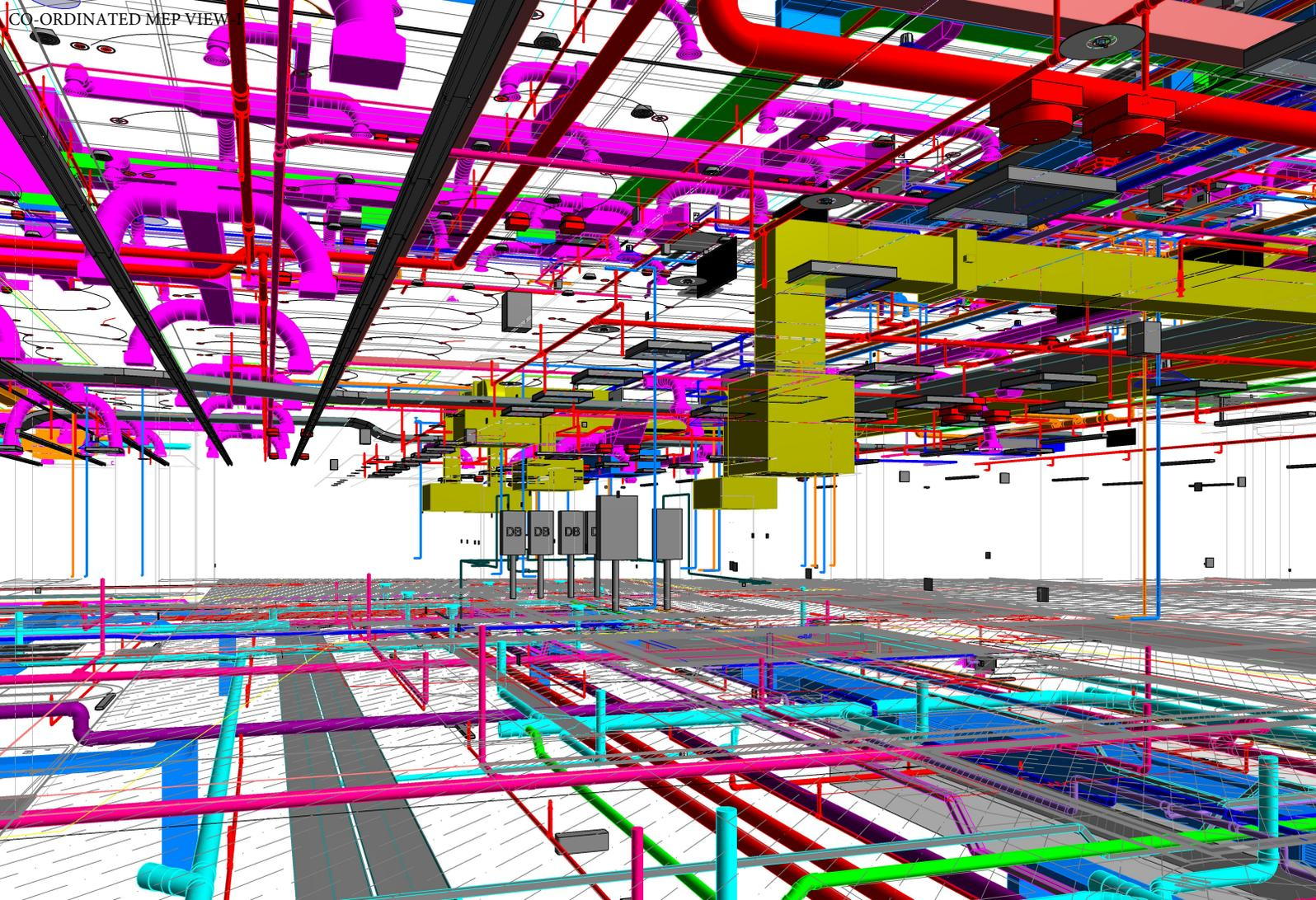

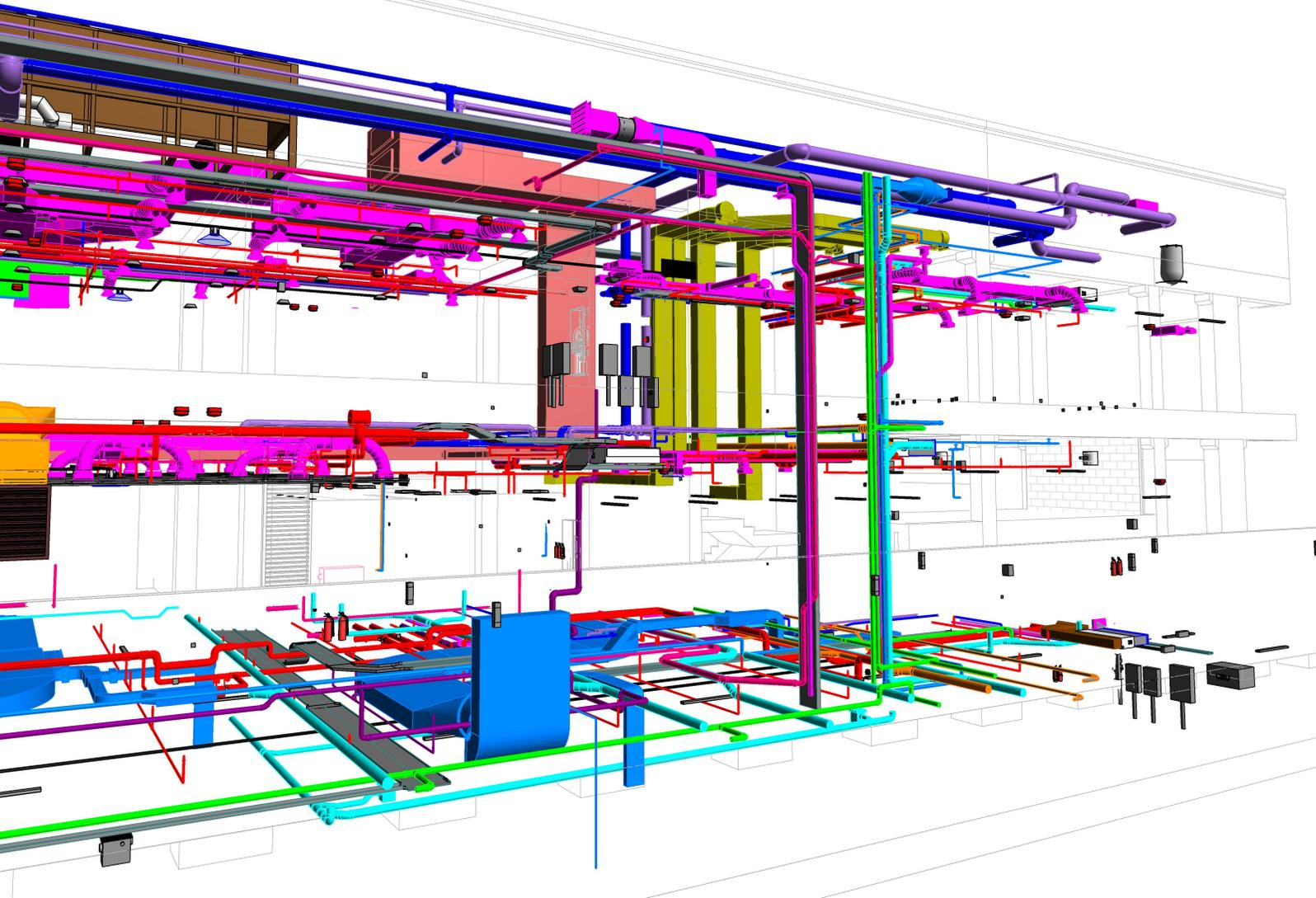

CO-ORDINATED MEP VIEW-III

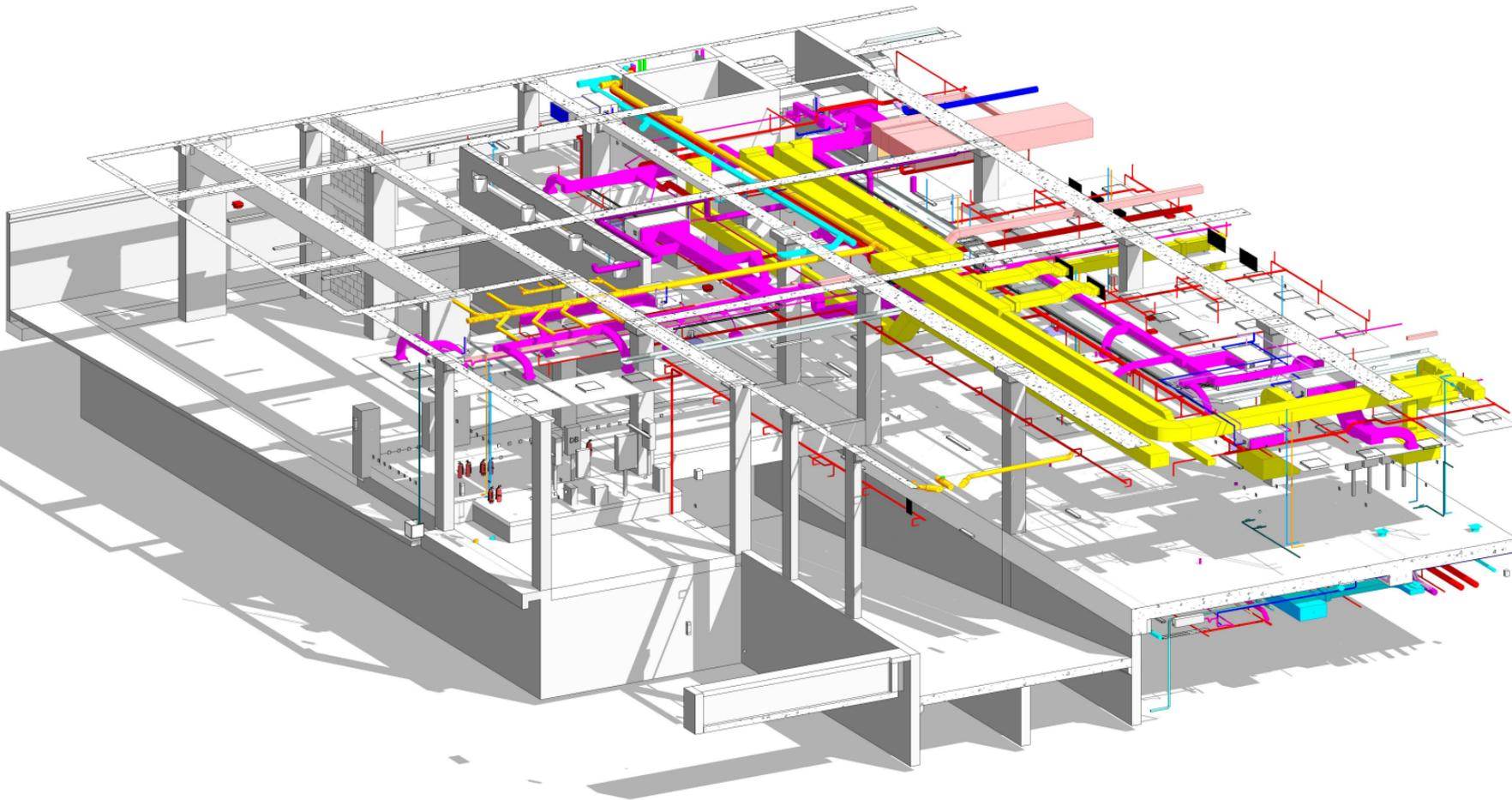

ELECTRICAL SUB STATION WITH BUST DUCT AND CABLE TRAYS

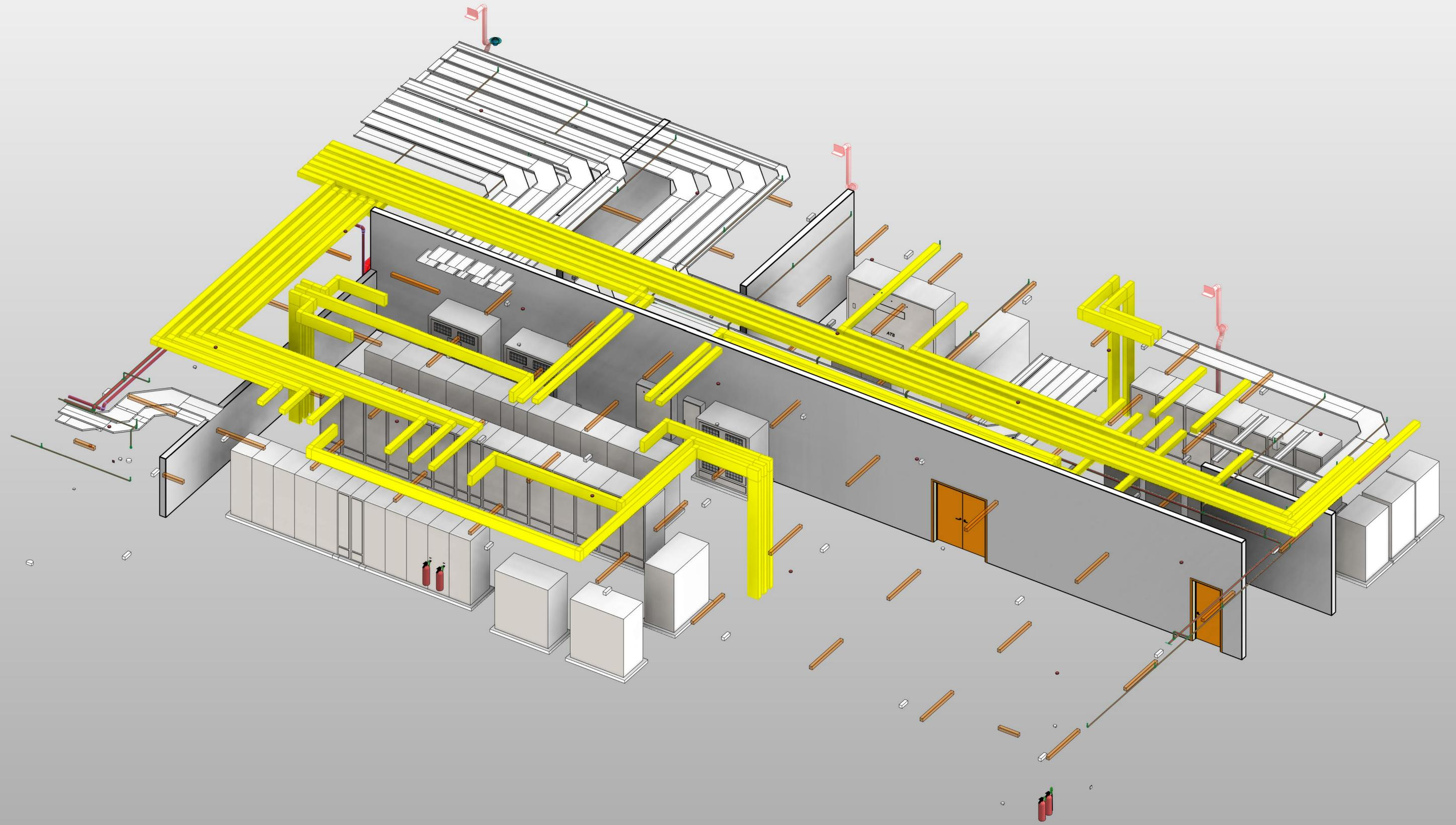

FIRE PUMP ROOM

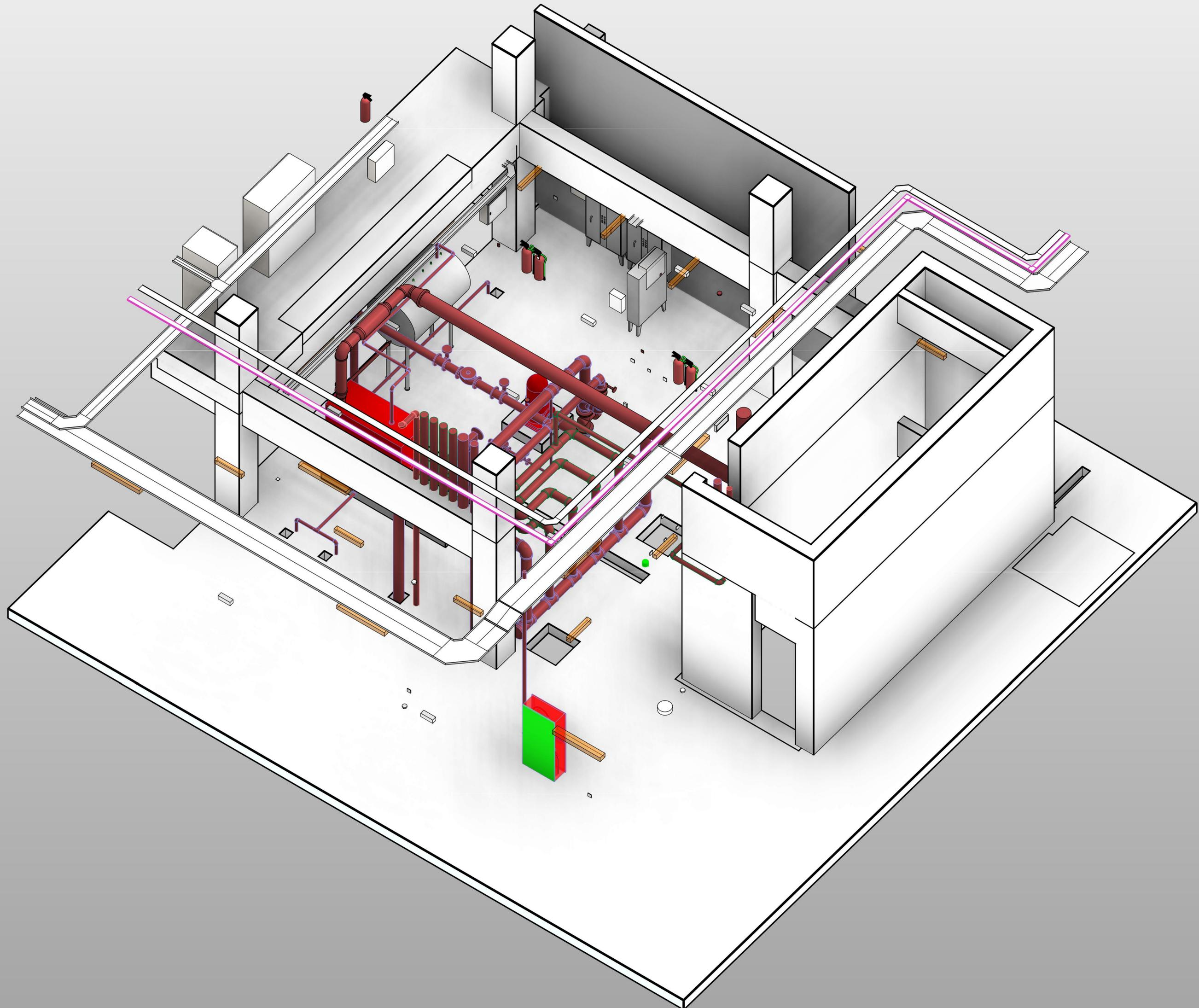

ISOMETRIC VIEW OF THE COMPLETE FACILITY

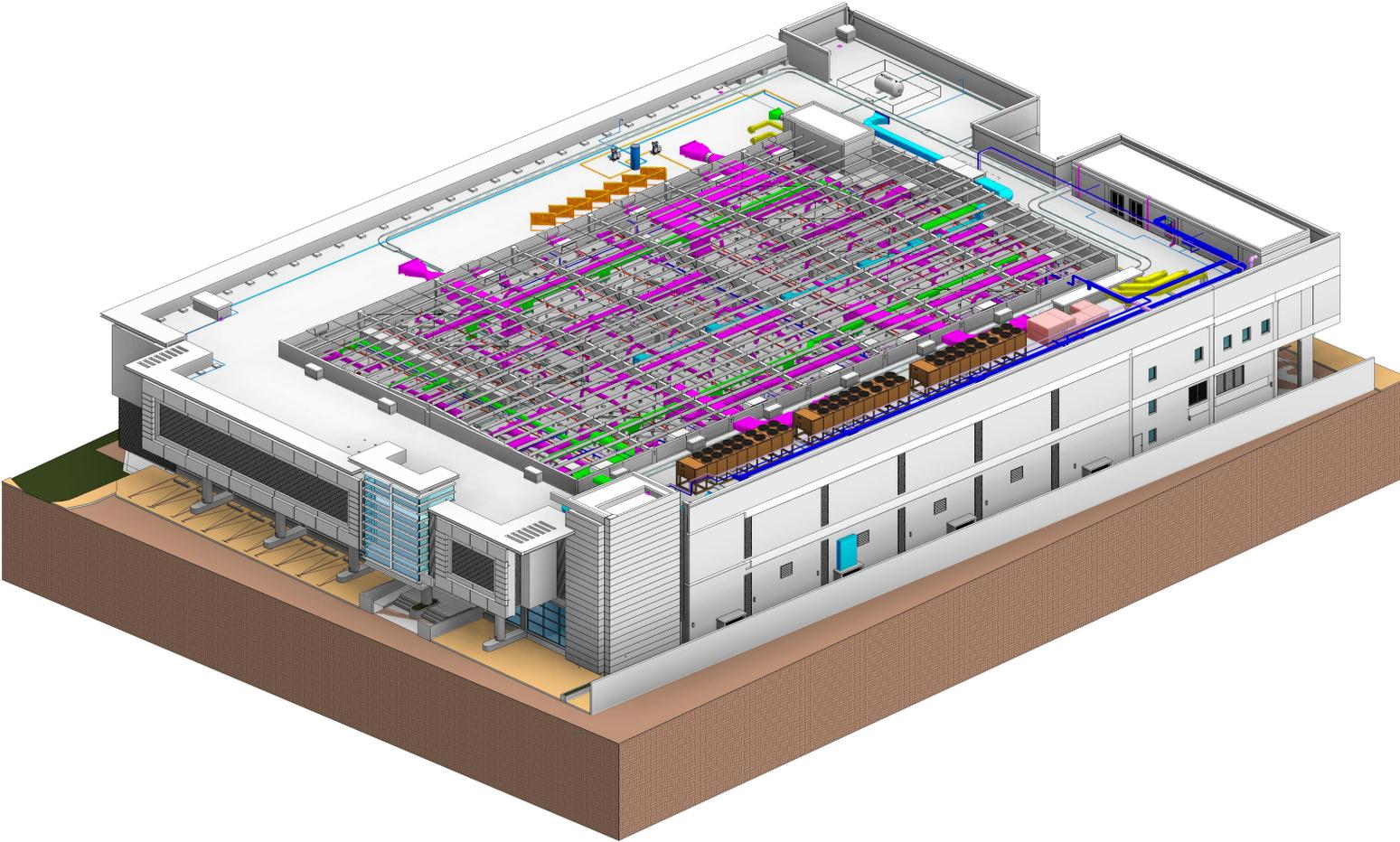

MECHANICAL PLANT ROOM-I

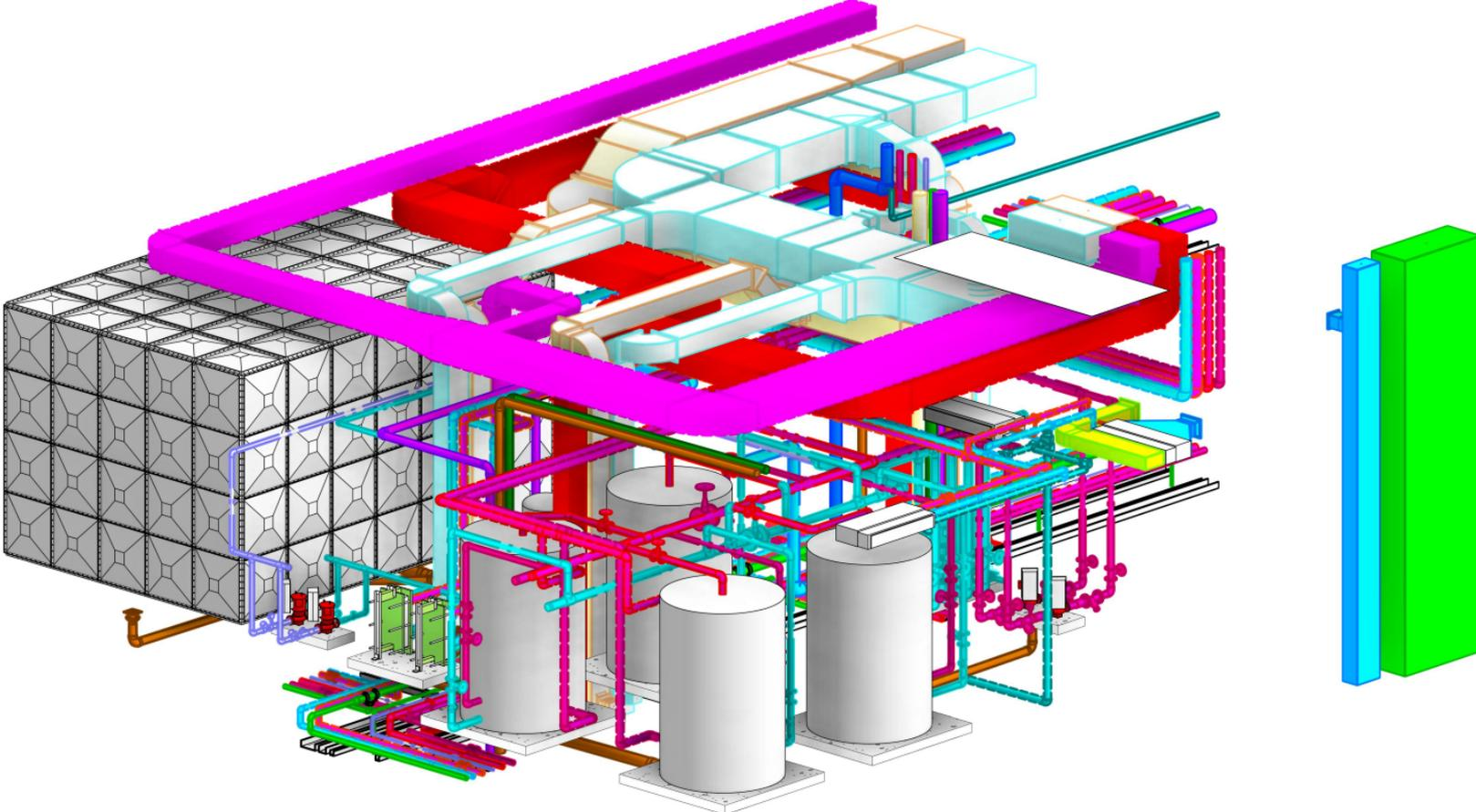

MECHANICAL PLANT ROOM-II

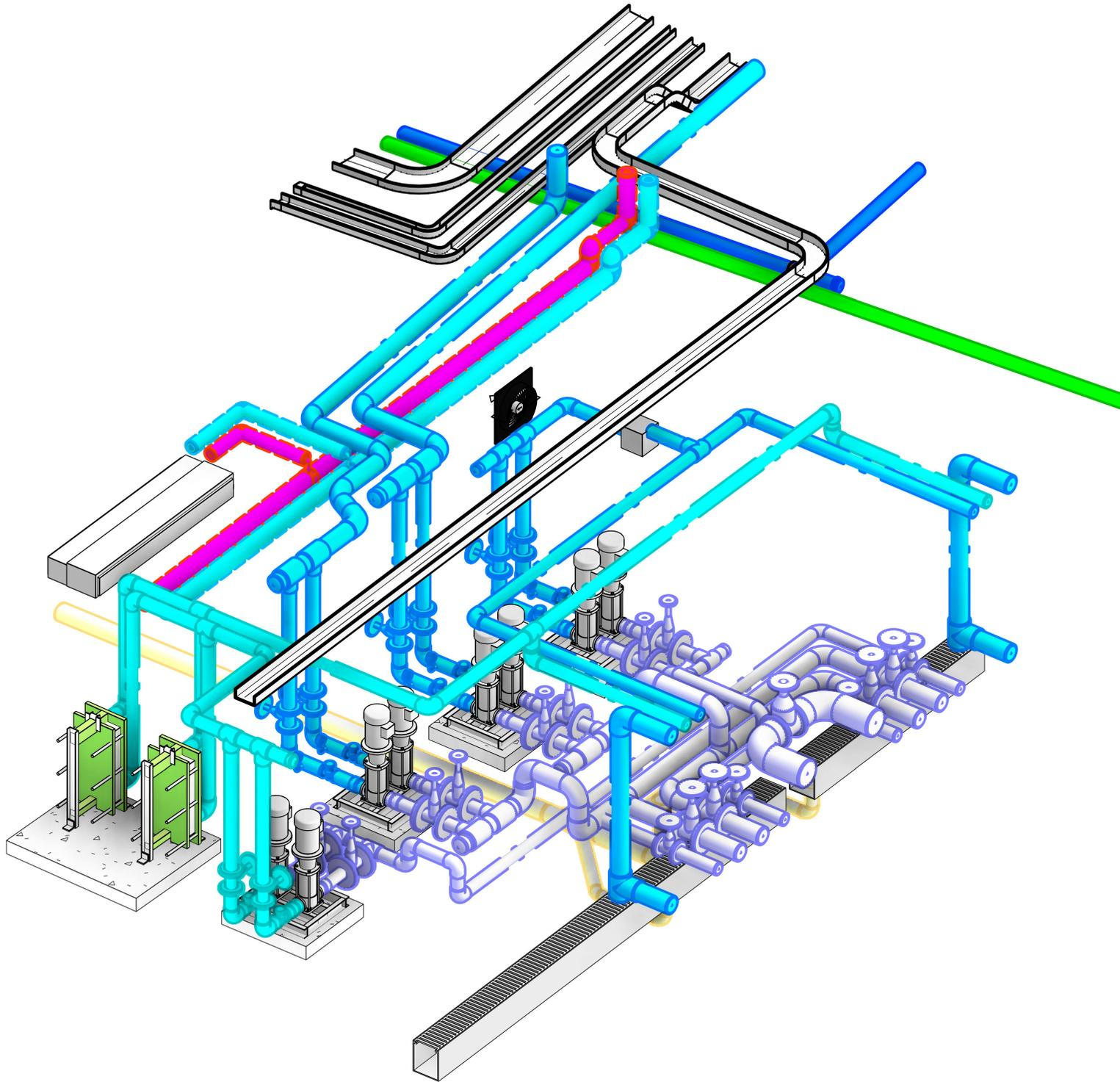

MECHANICAL PLANT ROOM-III

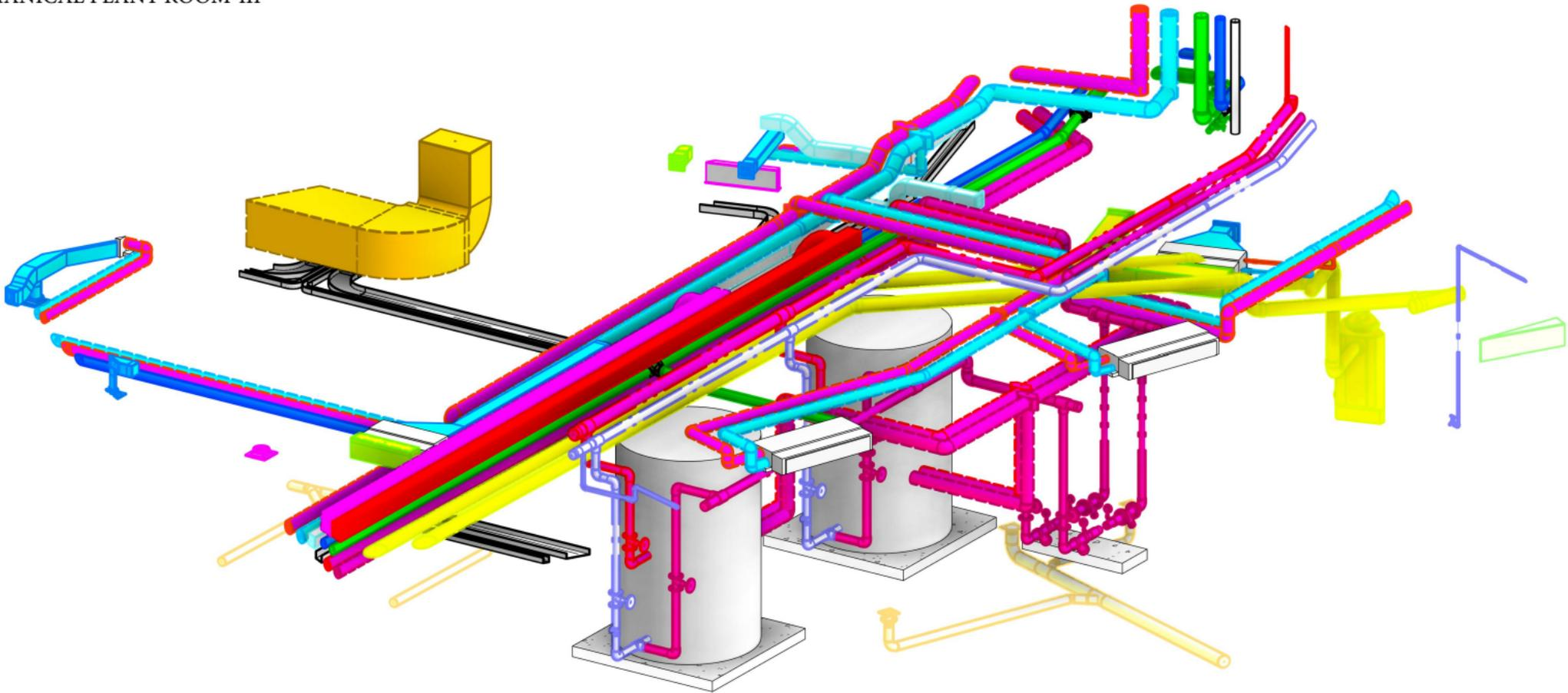

MECHANICAL PLANT ROOM-IV

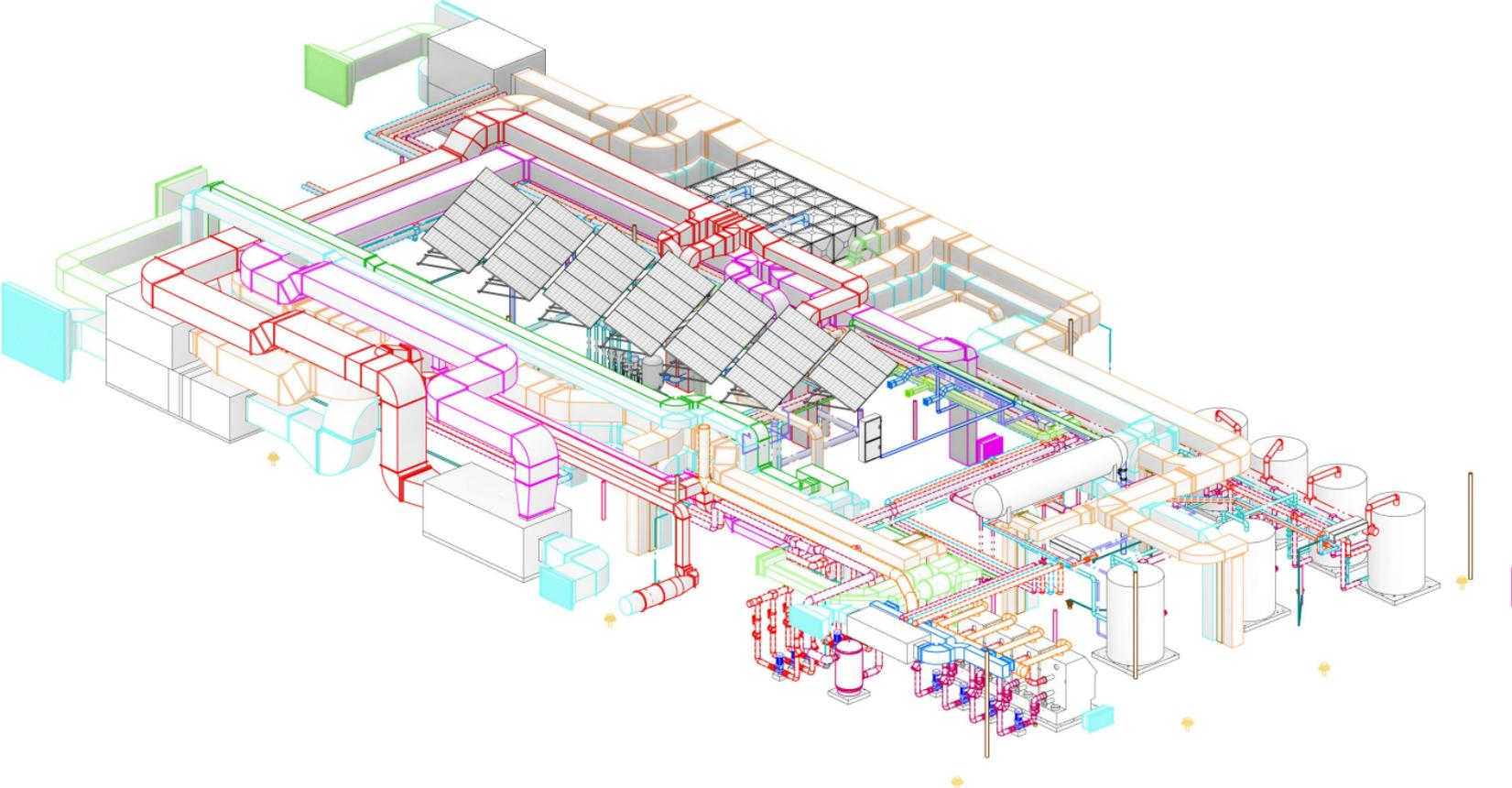

MECHANICAL PLANT ROOM PLAN

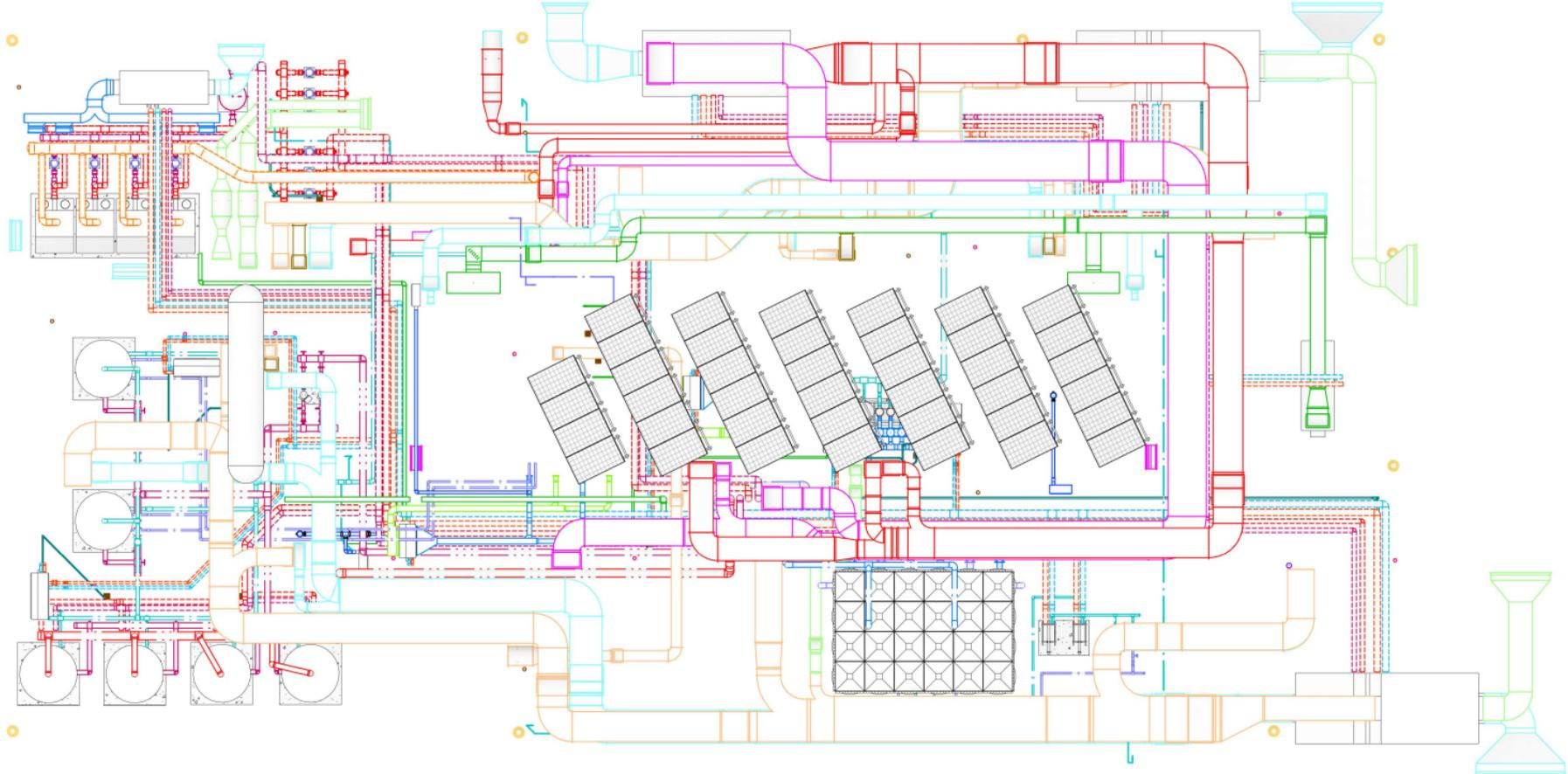

MECHANICAL PLANT ROOM-V

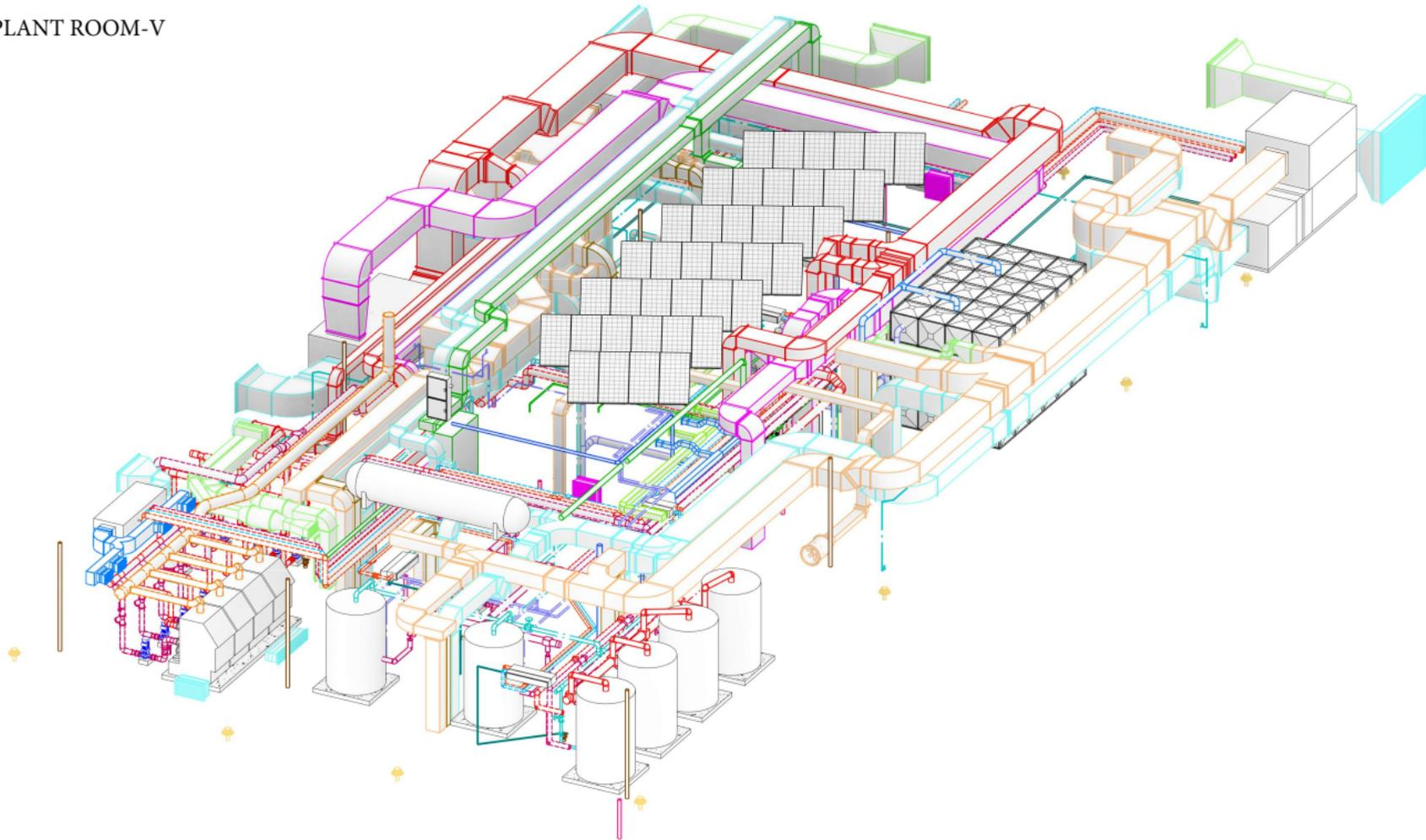

PLUMBING PLANT ROOM

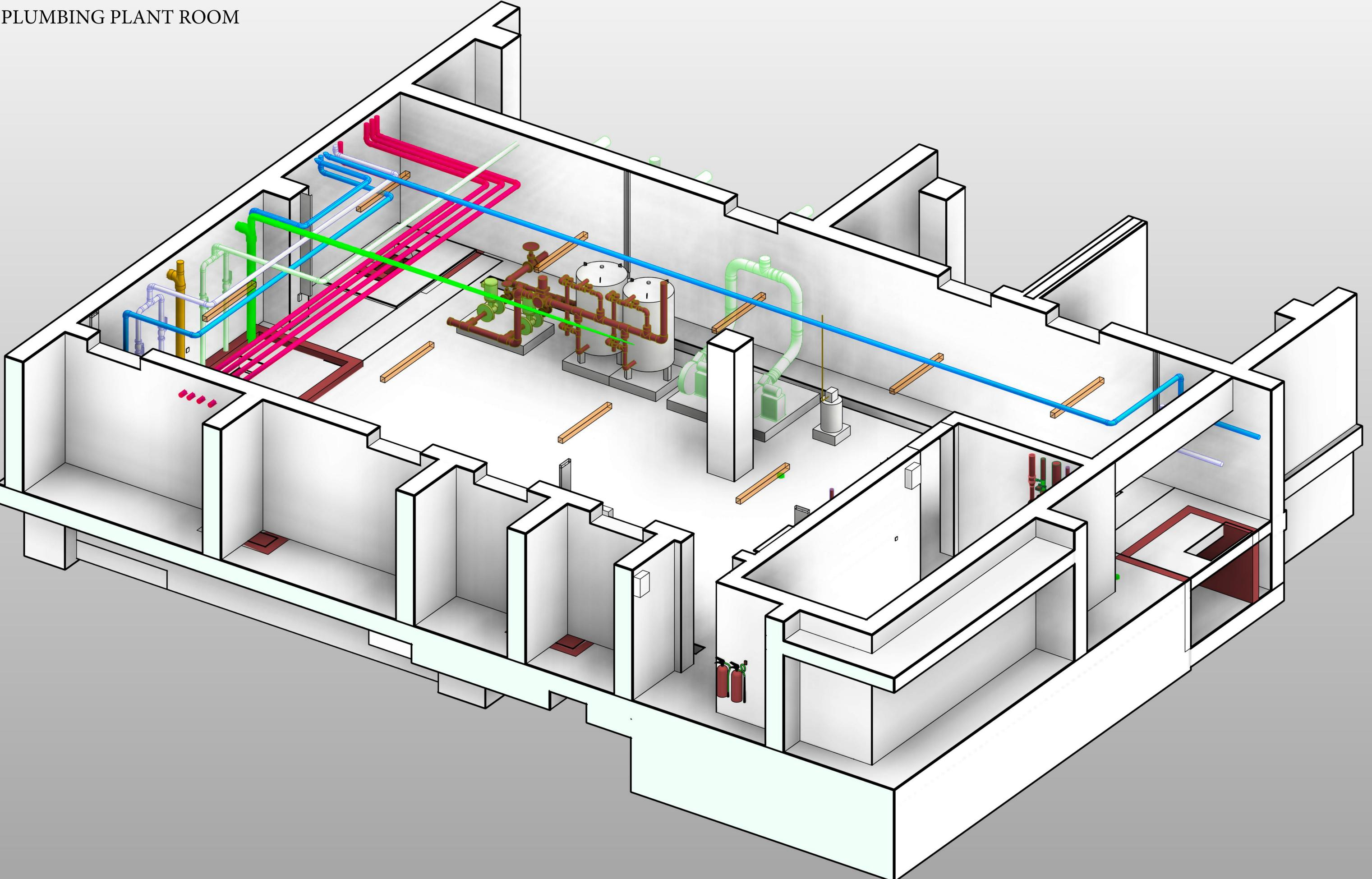

SOLAR PLANT ROOM AT ROOF

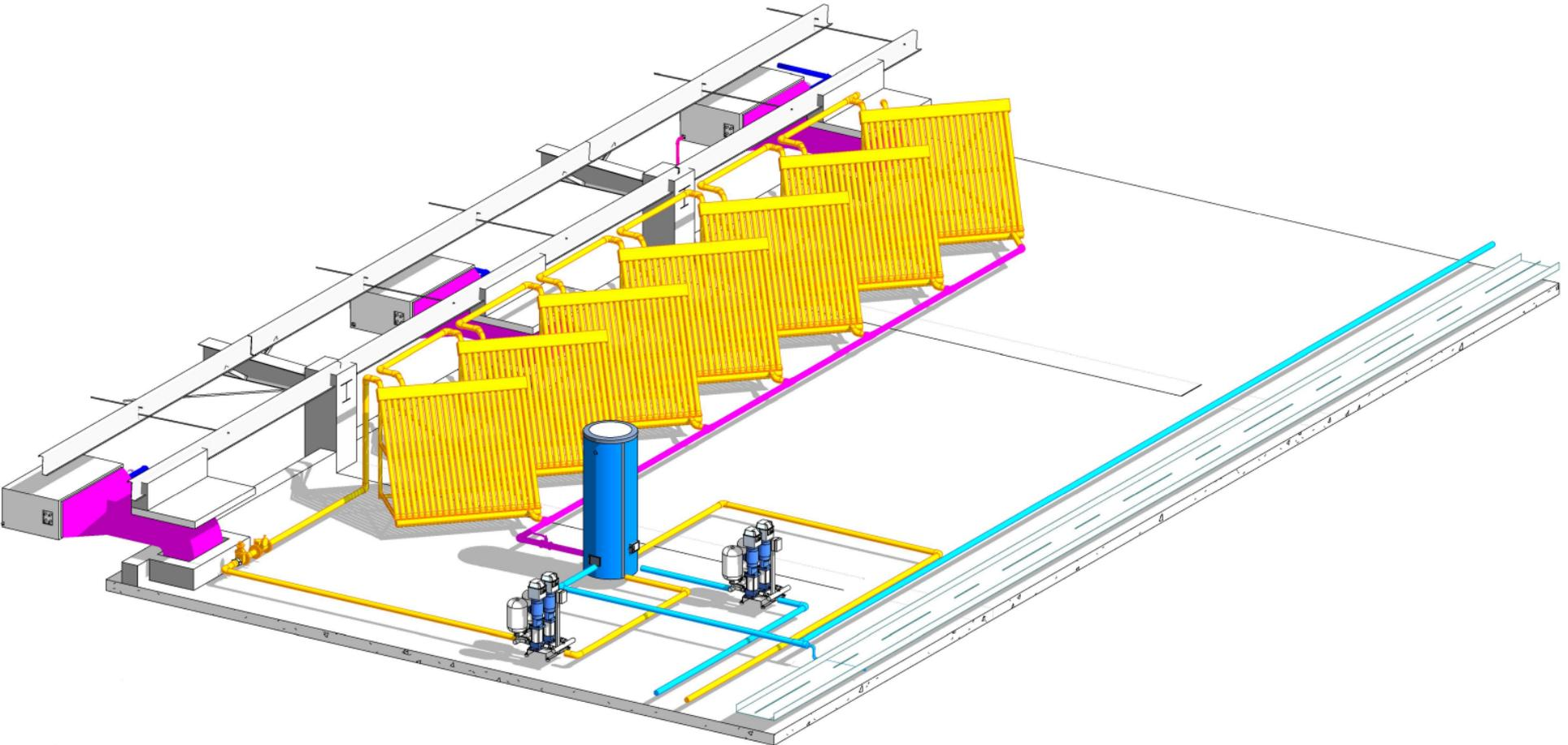

THANK YOU